

ORGANIC CHEMISTRY



OIL and its many useful PRODUCTS



The origin of oil

- **Crude oil** is **formed** from organic material of the remains of plant and animal organisms that lived millions of years ago. These remains form sediments eg at the bottom of seas, and become **buried** under layers of sedimentary rock. They decay, **without air (oxygen)**, under the action of **heat and pressure** to form crude oil over millions of years.
- It is a **fossil fuel** because it is formed from once living organisms and the Sun is the original source of energy. It is a **non-renewable** and **finite (limited reserves) energy** resource because it takes millions of years to form and we burn it faster than its is formed! It is also known as a **finite energy resource** because it will eventually run out! We do not have unlimited oil reserves!
- **Coal** and **natural gas** (mainly methane CH_4 and often found with oil) are **also non-renewable fossil fuels** formed from the remains of plants or animals.
- When the **fossil fuels are burned** the 'carbon', as **carbon dioxide**, is returned to the living environment, gets used up in **photosynthesis**, the plant material decays or is eaten by animals, so completing the **carbon cycle**.



The SEPARATION of the crude oil mixture into fractions and the USES of these fractions

A **fraction** is a mixture of a restricted boiling point range of molecules, they have a similar number of carbon atoms and physical properties. The uses of the fractions depend on their physical and chemical properties.

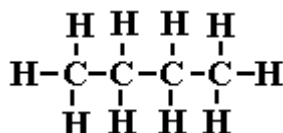

- Hydrocarbon molecules are **only** made of a chemical combination of carbon and hydrogen atoms.
- They are compounds because they consist of atoms of at least two different elements.

- Crude oil is a complex **mixture** of mainly **hydrocarbon** compound molecules. A mixture consists of two or more **elements or compounds** which are **not chemically combined**. The chemical properties of each substance in the mixture is unchanged.
- This means crude oil can be separated by physical methods, in this case **fractional distillation**, because they have **different boiling and condensation points**.
- The most volatile fraction, ie with the lowest boiling point, boils or evaporates off first and goes to the top of the column.
- The rest separate out according to their boiling point so that the highest boiling fraction, ie the **less volatile with higher boiling points**, tend to **condense more easily** lower down the column.
- The bigger the molecule, the greater the intermolecular forces, so the higher the boiling point. Chemical bonds are not broken in the process, only the intermolecular force of attraction.

THE FRACTIONAL DISTILLATION OF CRUDE OIL		names of fractions	C atoms in the molecule	boiling range in °C	USES of the fraction
<p>fractionating column to separate the components in crude oil</p> <p>decrease in ..</p> <ul style="list-style-type: none"> boiling point viscosity carbon atoms in molecule <p>increase in ...</p> <ul style="list-style-type: none"> volatility ease of ignition <p>crude oil</p> <p>heater 400°C</p>	Fuel Gas, LPG, Refinery Gas	1 to 4	-160 to 20°C	methane gas fuel, C ₃₋₄ easily liquefied, portable energy source bottled gas for cooking (butane), higher pressure cylinders (propane)	
	Gasoline, Petrol	5 to 11	20 to 60°C	easily vaporised, highly flammable, easily ignited, car fuel	
	Naphtha	7 to 13	60 to 180°C	no good as a fuel, but valuable source of organic molecules to make other things, cracked to make more petrol and alkenes	
	Paraffin, Kerosene	10 to 16	120 to 240°C	less flammable than petrol, domestic heater fuel, jet fuel	
	Diesel oil, Gas oil	15 to 25	220 to 250°C	Car and larger vehicle fuel	
	Fuel and lubricating Oils and Waxes	20 to 70	250 to 350°C	not so easily evaporated, not as flammable, safe to store for central heating oil, quite viscous (sticky) and can also be used for lubricating oils, clear waxes and polishes	
	Bitumen	over 70	over 350°C	forms a thick, black, tough and resistant adhesive on cooling, used as waterproofing material and to sticks rock chips on roofs or road surfaces	



More on examples of relating the physical properties of the fractions to their uses and dangers

down

the list the molecule gets bigger, more viscous, higher boiling and less flammable

- The refinery gas fractions, under pressure, are conveniently pumped to burner systems, but are easily ignited and explosive.
- Vehicle fuels must be liquid for compact and convenient storage but they must be easily vapourised to mix with air in the engine prior to ignition. The ease of vaporisation does however make them flammable!
- Paraffin and kerosine are less flammable and safer, but not as easily ignited.
- Fuel oil is not too viscous to pump to a central heating burner, and it is not very volatile and so not as flammable and dangerous as petrol or diesel etc. for domestic use.
- Lubricating oil must be quite viscous to stick onto surfaces. Smaller molecules might be more runny but they would evaporate away! It is also water repellent and helps reduce corrosion on moving machine parts.
- Candle wax is very convenient as a solid for humble lamp (especially in power cuts!), but via a wick, the heat from the flame is sufficient to vaporise the hydrocarbons to burn them.
- Bitumen is a water repellent solid at room temperature but is readily melted (sometimes too easily in hot weather). Used as base for a road chipping top surface or sometimes directly. It is also used to waterproof roofing felt.

Mega Lecture

TABLE 25.4 Common Functional Groups in Organic Compounds				
Functional Group	Type of Compound	Suffix or Prefix	Example	Systematic Name (common name)
	Alkene	<i>ene</i>		Ethene (ethylene)
$\text{—C}\equiv\text{C—}$	Alkyne	<i>-yne</i>		Ethyne (acetylene)
	Alcohol	<i>-ol</i>		Methanol (methyl alcohol)
	Ether	<i>ether</i>		Dimethyl ether
 (X = halogen)	Haloalkane	<i>halo-</i>		Chloromethane (methyl chloride)
	Amine	<i>-amine</i>		Ethylamine
	Aldehyde	<i>-al</i>		Ethanal (acetaldehyde)
	Ketone	<i>-one</i>		2-Propanone (acetone)
	Carboxylic acid	<i>-oic acid</i>		Ethanoic acid (acetic acid)
	Ester	<i>-oate</i>		Methyl ethanoate (methyl acetate)
	Amide	<i>-amide</i>		Ethanamide (acetamide)

The ALKANE series of hydrocarbons	
<p>Alkanes are a group of hydrocarbon molecules in which all the carbon and hydrogen atoms are only joined by single covalent bonds (eg C-H or C-C). Alkanes are known as saturated molecules because other atoms cannot add to them (compare alkenes further on). The first four in the series are shown. They are not very reactive unless burned!</p> <p>(1) is the molecular formula: a summary of the totals of each atoms of each element in one molecule; (2) is a 'shorthand' version of the structural formula (3); (3) is called the structural formula: it shows how all the atoms are linked with the covalent bonds -; (4) is a '3D' representation of the structural formula (3)</p>	
<p>(1) CH₄, (3) , (4) </p>	<p>methane (main molecule in natural gas)</p>
<p>(1) C₂H₆ (2) CH₃-CH₃ (3)  (4) </p>	<p>ethane</p>
<p>(1) C₃H₈ (2) CH₃-CH₂-CH₃ (3) </p>	<p>propane</p>
<p>(1) C₄H₁₀ (2) CH₃-CH₂-CH₂-CH₃ (3) </p>	<p>butane</p>

TABLE 25.1 First Several Members of the Straight-Chain Alkane Series

Molecular Formula	Condensed Structural Formula	Name	Boiling Point (°C)
CH ₄	CH ₄	Methane	-161
C ₂ H ₆	CH ₃ CH ₃	Ethane	-89
C ₃ H ₈	CH ₃ CH ₂ CH ₃	Propane	-44
C ₄ H ₁₀	CH ₃ CH ₂ CH ₂ CH ₃	Butane	-0.5
C ₅ H ₁₂	CH ₃ CH ₂ CH ₂ CH ₂ CH ₃	Pentane	36
C ₆ H ₁₄	CH ₃ CH ₂ CH ₂ CH ₂ CH ₂ CH ₃	Hexane	68
C ₇ H ₁₆	CH ₃ CH ₂ CH ₂ CH ₂ CH ₂ CH ₂ CH ₃	Heptane	98
C ₈ H ₁₈	CH ₃ CH ₂ CH ₂ CH ₂ CH ₂ CH ₂ CH ₂ CH ₃	Octane	125
C ₉ H ₂₀	CH ₃ CH ₂ CH ₂ CH ₂ CH ₂ CH ₂ CH ₂ CH ₂ CH ₃	Nonane	151
C ₁₀ H ₂₂	CH ₃ CH ₂ CH ₂ CH ₂ CH ₂ CH ₂ CH ₂ CH ₂ CH ₂ CH ₃	Decane	174

TABLE 25.2 Condensed Structural Formulas and Common Names for Several Alkyl Groups

Group	Name
CH ₃ —	Methyl
CH ₃ CH ₂ —	Ethyl
CH ₃ CH ₂ CH ₂ —	Propyl
CH ₃ CH ₂ CH ₂ CH ₂ —	Butyl
$\begin{array}{c} \text{CH}_3 \\ \\ \text{HC}— \\ \\ \text{CH}_3 \end{array}$	Isopropyl
$\begin{array}{c} \text{CH}_3 \\ \\ \text{CH}_2—\text{C}— \\ \\ \text{CH}_3 \end{array}$	<i>t</i> -Butyl

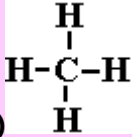
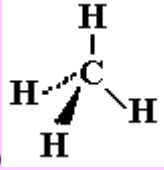
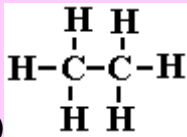
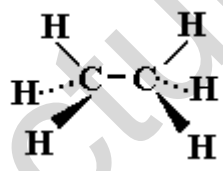
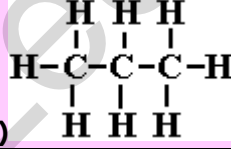
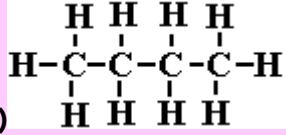

The complete combustion of hydrocarbons

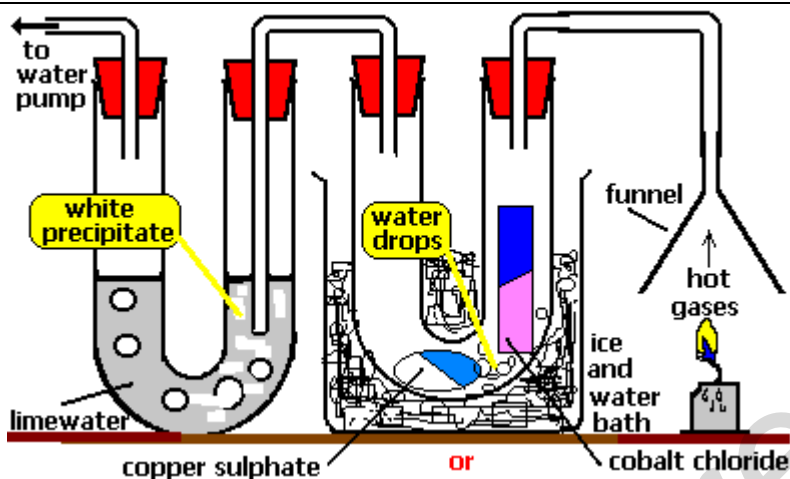

- When hydrocarbons are burned in air a fast **exothermic** reaction occurs releasing heat and forming **carbon dioxide** and **water**.
- It is an **oxidation reaction** due to O gain by C and H.
- The **carbon dioxide is chemically detected with limewater** - with which it forms a **white precipitate** (milky appearance) of calcium carbonate.
- The **water is chemically detected** either by (i) anhydrous **white copper sulphate turning blue** OR (ii) anhydrous **blue cobalt chloride paper turning pink**.
- A **physical test** for water is to measure its **boiling point** (should be **100°C**).

Equations for the complete combustion of a hydrocarbon



hydrocarbon + oxygen => carbon dioxide + water

eg word equation: methane + oxygen => carbon dioxide + water

and the symbol equation: $\text{CH}_{4(g)} + 2\text{O}_{2(g)} \Rightarrow \text{CO}_{2(g)} + 2\text{H}_2\text{O}_{(l)}$

(one CO_2 for every C and one H_2O for every two H's in the hydrocarbon molecule)

for ethane the symbol equation (more awkward) is ...

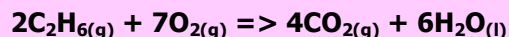

and for pentane the symbol equations is ...

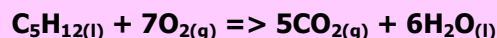



The Incomplete Combustion of hydrocarbons



CO

- If there is **not enough oxygen** present to completely burn the fuel to carbon dioxide and water other products may form causing **pollution and fuel inefficiency**.
- The most common partially burned products are likely to be **carbon C (soot)** and deadly **carbon monoxide CO**.
- It would appear that the hydrogen in the fuel molecules is more easily burned and usually forms water.
- There is also **less heat released compared to complete combustion**.
 - eg $\text{CH}_{4(g)} + \text{O}_{2(g)} \Rightarrow \text{C}_{(s)} + 2\text{H}_2\text{O}_{(l)}$
 - **or** $2\text{CH}_{4(g)} + 3\text{O}_{2(g)} \Rightarrow 2\text{CO}_{(g)} + 4\text{H}_2\text{O}_{(l)}$
- Therefore it is extremely important that any combustion system is as efficient as possible eg gas heaters, furnaces etc. must all have excellent ventilation for complete combustion to harmless water and carbon dioxide.
- **If there is any smell of gas, make sure (i) all appliances are turned off, (ii) all sources of ignition are absent, and (iii) ring the gas board!**
- Faulty gas appliances have led to tragic deaths. **Carbon monoxide** is **colourless** and **odourless** and even **low concentrations** in the air can be **fatal**.
- Carbon monoxide is unfortunately emitted by all car exhausts, though **catalytic converters** help reduce this by converting nitrogen monoxide (another pollutant) and carbon monoxide into harmless nitrogen and carbon dioxide.
 - $2\text{NO}_{(g)} + 2\text{CO}_{(g)} \Rightarrow \text{N}_{2(g)} + 2\text{CO}_{2(g)}$

What makes a good fossil fuel?

Factors that should be taken into consideration

- **Energy value:** eg kJ of heat energy released per kg;
- **Availability:** Geographical convenience, oil production levels;
- **Storage:** Health and safety issues eg coal very safe, natural gas more dangerous
- **Cost:** Extraction, transport, market price
- **Toxicity and Pollution:** Greenhouse effect (which produces the least or most CO_2 /energy released?); sulphur content of fuel (most removed before fuel used to minimise sulphur dioxide and acid rain formation); efficiency of combustion eg minimum carbon monoxide and soot levels
- **Ease of use:**
-

The ALKENE hydrocarbons series

Alkenes are hydrocarbons containing a **double bond** as well as single bonds. These are called **unsaturated molecules** because two atoms can join onto the bond when it opens up. The first two in the series are shown below. They are extremely reactive and important compounds in the chemical industry and are converted into very useful compounds eg plastics. They are made from **cracking** processes (see below)

(1) is the **molecular formula**: a **summary** of the totals of each **atoms** of each element in one molecule; **(2)** is a '**shorthand**' version of the structural or displayed formula **(3)**; **(3)** is called the **structural or displayed formula**: it shows how all the atoms are linked with the covalent bonds -

$(1) \text{C}_2\text{H}_4$, $(2) \text{CH}_2=\text{CH}_2$, $(3) \begin{array}{c} \text{H} \quad \text{H} \\ \diagdown \quad / \\ \text{C}=\text{C} \\ / \quad \diagdown \\ \text{H} \quad \text{H} \end{array}$	ethene
$(1) \text{C}_3\text{H}_6$, $(2a) \text{CH}_3-\text{CH}=\text{CH}_2$, $(2b) \begin{array}{c} \text{CH}_3 \quad \text{H} \\ \diagdown \quad / \\ \text{C}=\text{C} \\ / \quad \diagdown \\ \text{H} \quad \text{H} \end{array}$, $(3) \begin{array}{c} \text{H} \quad \text{H} \quad \text{H} \\ \diagdown \quad / \quad \diagdown \\ \text{H}-\text{C} \quad \text{C}=\text{C} \\ / \quad \diagdown \quad \diagdown \\ \text{H} \quad \text{H} \quad \text{H} \end{array}$	propene
$(1) \text{C}_4\text{H}_8$, $(2) \text{CH}_3-\text{CH}_2-\text{CH}=\text{CH}_2$	butene

A test to distinguish between ALKANE and ALKENE hydrocarbons

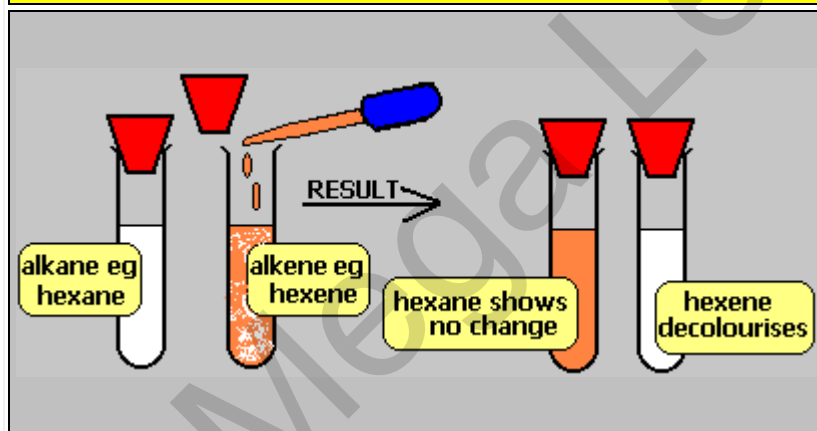

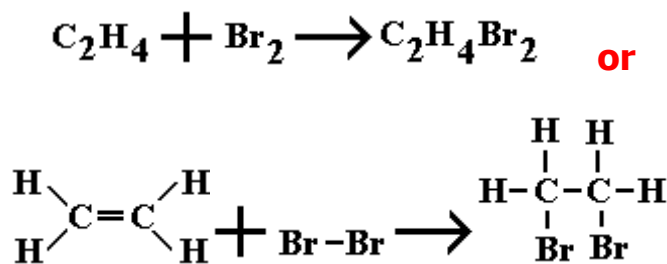

Hydrocarbons are colourless. **Bromine** dissolved in water or trichloroethane solvent forms an **orange** (yellow/brown) solution. When bromine solution is added to both an alkane or an alkene the result is quite different. The **alkane solution remains orange** - no reaction. However, the **alkene decolourises the bromine** as it forms a colourless dibromo-alkane compound - see equations

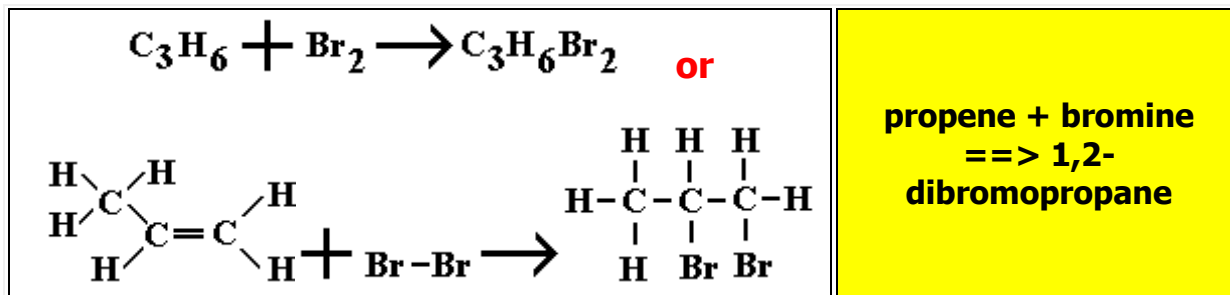

- **Alkenes are unsaturated** molecules, **atoms can add** to them via the **C=C** double bond, so a reaction occurs.
- **Alkanes are saturated** - no double bond - and **atoms cannot add** - so no reaction.

ethene + bromine ==> 1,2-dibromethane

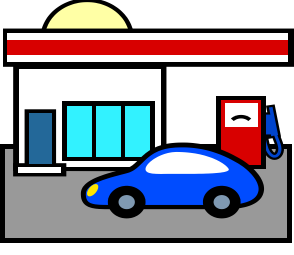

	<p>CRACKING a problem!!</p> <p>there isn't enough petrol in crude oil! AND crude oil doesn't have any alkenes in it for plastics!</p>	
---	--	---

- When crude oil has been distilled into useful fractions it is found that the **quantities** produced **do not match** the ratio required for **commercial needs** eg we have an insatiable **appetite for petrol and diesel** in our cars and there are too many left-overs of the larger molecules which do not make good fuels or have other uses. Fuel oil, naphtha and bitumen in crude oil exceed demand.
- Also, **alkenes are not found in crude oil** and they are one of the most valuable types of organic molecule in the chemical industry eg to make polymers (plastics) or ethanol (an alcohol).
- The two deficiencies are remedied by the process of cracking which converts useless big molecules into useful smaller ones.
- CRACKING** is done by heating some of the less used fractions to a **high temperature** vapour and passing over a suitable hot **catalyst**. The cracking reaction is an example of **thermal decomposition** - a **reaction that breaks down molecules into smaller ones using heat**. The main products from **cracking alkanes from oil** are **smaller alkanes (eg for petrol or diesel) and alkenes (eg for plastics)**.
- The **equations below** illustrate the process, small molecules are used to show the overall molecular change clearly BUT in practice the 'starter' molecules are likely to be more those shown in equations (3) and (4). The **cracking involves breaking single carbon-carbon bonds** to form the alkanes (saturated hydrocarbons) and alkenes (unsaturated hydrocarbons) products

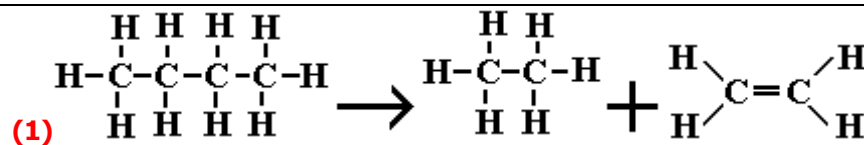

butane \longrightarrow ethane + ethene or

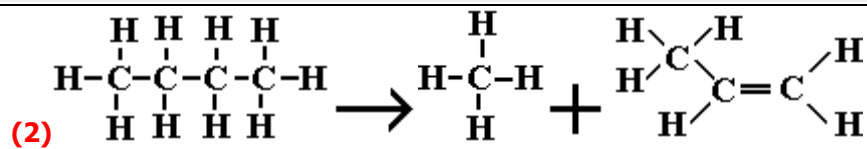

butane \rightarrow methane + propene

lots and lots of other possibilities! eg

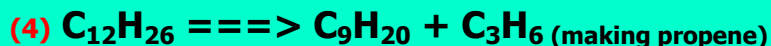
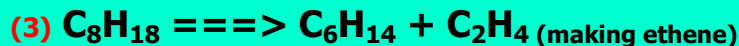

The formation of POLYMERS and the USES of PLASTICS - Macromolecules



The formation of big polymer molecules called polyalkenes from small molecules called alkenes

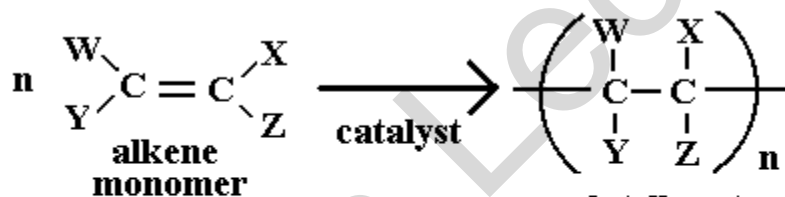

eg n ethene \implies poly(ethene)
 n = very large number

W, X, Y or Z can be
H, F, Cl or CH_3 etc.

- When **catalysed and heated under pressure**, alkenes link together when the **double bond opens**. The spare bonds are used to **join up the molecules**.
- The original **small molecule** is called the **monomer** and the **long molecule** is called the **polymer**, which is the sort of molecule most **plastics** consist of. The **polymer is now a saturated molecule** but has the same C:H ratio as the original alkene.
- So lots of small molecules join up to form a big long molecule in a process called **addition polymerisation** and the polymers are named as poly(name of original alkene).

Examples of Polymer Molecules - formation and uses

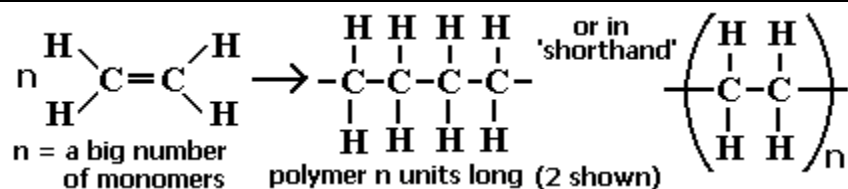

Poly(ethene) from ethene is a cheap but very useful plastic used for plastic bags and bottles.

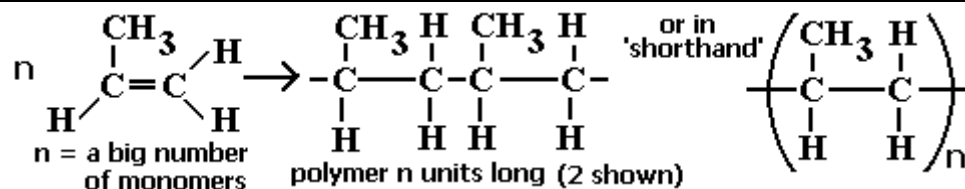

Poly(propene) from propene is **stronger** and more hard wearing than polythene and is used for making crates, fibres and ropes.

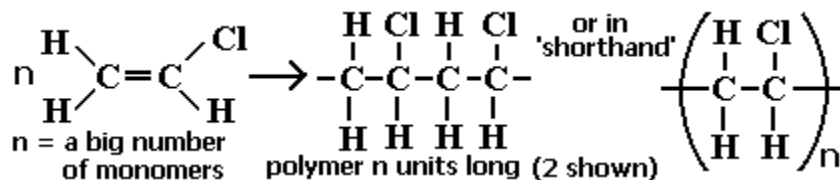

Poly(chloroethene), old name **PVC**, from chloroethene (vinyl chloride) is tougher than poly(ethene) and very hard wearing and has good heat stability, so is used for covering electrical wiring and plugs. It also replacing metals as gas and water drain pipes and has found a use as artificial leather and readily dyed to bright colours!

Polystyrene is made from styrene (another alkene monomer) and is used in a gas expanded form for packaging and insulation.

Mega Lecture

TABLE 12.1 Polymers of Commercial Importance			
Polymer	Structure	Uses	Quantity (10 ⁹ lb/yr)*
Addition polymers (—CH ₂ —CH ₂ —) _n			
Polyethylene	$\left[-\text{CH}_2-\text{CH}_2- \right]_n$	Films, packaging, bottles	23
Polypropylene	$\left[-\text{CH}_2-\underset{\text{CH}_3}{\text{CH}}- \right]_n$	Kitchenware, fibers, appliances	9.5
Polystyrene	$\left[-\text{CH}_2-\underset{\text{C}_6\text{H}_5}{\text{CH}}- \right]_n$	Packaging, disposable food containers, insulation	5.8
Polyvinyl chloride	$\left[-\text{CH}_2-\underset{\text{Cl}}{\text{CH}}- \right]_n$	Pipe fittings, clear film for meat packaging	11
Condensation polymers			
Polyurethane	$\left[-\underset{\text{O}}{\text{C}}-\text{NH}-\text{R}-\text{NH}-\underset{\text{O}}{\text{C}}-\text{O}-\text{R}'-\text{O}- \right]_n$ R, R' = for example, —CH ₂ —CH ₂ —	"Foam" furniture stuffing, spray-on insulation, automotive parts, footwear, water-protective coatings	1.5
Polyethylene terephthalate (a polyester)	$\left[-\text{O}-\text{CH}_2-\text{CH}_2-\text{O}-\underset{\text{O}}{\text{C}}-\text{C}_6\text{H}_4-\underset{\text{O}}{\text{C}}- \right]_n$	Tire cord, magnetic tape, apparel, soft-drink bottles (all polyesters)	3.8
Nylon 6,6	$\left[-\text{NH}-(\text{CH}_2)_6-\text{NH}-\underset{\text{O}}{\text{C}}-(\text{CH}_2)_4-\underset{\text{O}}{\text{C}}- \right]_n$	Home furnishings, apparel, carpet fibers, fishing line (all nylons)	2.7

*Source: *Chemical and Engineering News*, June 26, 1998, p. 42

Three problems associated with using Polymers or Plastics

- Polymers or plastics cannot be easily broken down by microorganisms ie they are **not biodegradable**. This leads to waste disposal problems and 'non-rotting' litter around the environment and land-fill sites are getting full!
- When **plastic materials burn** they can **produce highly toxic gases** such as carbon monoxide, hydrogen cyanide and hydrogen chloride (particularly from PVC and other plastics containing chlorine and nitrogen). This has caused deaths in house fires and controversial problems with alleged inefficient waste incinerators and they will generally cause environmental problems if burning on waste tips etc.
- It is **difficult to recycle plastics** because of separation into the various sorts. It would be beneficial to prolong the life of the finite crude oil reserves AND reduce pollution and space in land-fill sites.
- **New plastics** are being developed which are **more biodegradable** or can be **recycled**, so will the paper bag and cardboard package make a comeback? (in Eire you have to bring your own bag or buy one, and not necessarily a plastic one!).

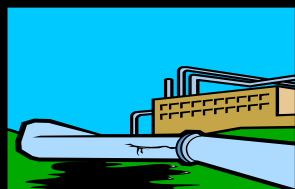

Oil Products and Environment Problems

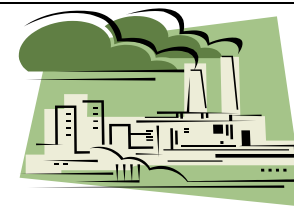

- Our economy, like many other countries has become very dependent on the extraction, sale and use of oil based products. BUT, there is **high price to be paid** at times whether it be pollution effects or warring countries with oil economics factors.
- Oil rig **accidents**, broken pipelines, oil tanker wrecks etc. all have **terrible effects** on the plant and animal life of the locality as we see from the horrible TV pictures of seabirds coated in oil, and toxic oil slicks covering the beaches and sands.
- The burning of oil and other fossil fuels is contributing to the '**Greenhouse Effect**' of global warming. The extra carbon dioxide forming absorbs and traps sunlight (or more precisely the re-radiated sunlight energy from the Earth's surface) rather like a greenhouse. The effects are predicted to be dramatic eg rising sea levels as polar ice melts causing flooding in low lying land regions, more energy in the global weather system leads to more frequent violent weather patterns, ..
- Fossil fuels contain the element **sulphur** or compounds of sulphur. When the fuel is burned the sulphur also burns to form **sulphur dioxide**. This is an **acidic gas** and dissolves in rainwater, it then reacts with water and oxygen to form a very dilute solution of **sulphuric acid**.
 - **Sulphur dioxide is a harmful gas** and lung irritant and contributed to 5000 extra deaths in the great 'London Smog' in the 1950's.
 - The formation of **acid rain** has several bad effects on the environment eg
 - the low pH causes plant damage, particularly trees,
 - kills certain life forms and so damages eco cycles and food chains in rivers or lakes harming wildlife like trout,
 - increases the 'weathering' corrosion rates of building stone (particularly limestone).
- High temperature combustion also produces **other pollutants** including ...
 - **Nitrogen oxides, NO and NO₂**, which are acidic and contribute further to acid rain (above), and are also involved in the chemistry of '**photochemical smog**' - which produces chemicals harmful to respiration and eyes. Many of the reactions are initiated by sunlight.
 - **Carbon monoxide CO**, which is **toxic**, and also involved in the chemistry of 'photochemical smog'. This is formed by inefficient combustion
 - **Unburned hydrocarbons, C_xH_y**, which can be carcinogenic and are also involved in photochemical smog chemistry.
 - But **catalytic converters*** can significantly reduced these three unwanted emissions (**see above** for CO and NO removal, and C_xH_y gets oxidised to CO₂ and H₂O). * eg using platinum-rhodium transition metal catalysts, these are dispersed on ceramic bed to give a big surface area for the best reaction rate.
- There are **other indirect pollution problems** to do with burning fossil fuels:
 - Lead compounds are added to petrol to improve engine performance. This produces lead compound emissions into the environment. Lead compounds are nerve toxins so it is fortunate they are being phased out in many countries.
 - Photochemical smog is mentioned in the previous paragraph.
- And finally, should we using a very **valuable source of organic chemicals** by merely burning most of it? AND **how long will oil reserves last?** AND what happens **if the oil runs out?**
- **Hydrogen gas can be used as fuel and a long-term possible alternative to fossil fuels.**
 - It burns with a pale blue flame in air reacting with oxygen to be oxidised to form water.
 - **hydrogen + oxygen ==> water** or $2\text{H}_{2(g)} + \text{O}_{2(g)} ==> 2\text{H}_2\text{O}_{(l)}$
 - It is a non-polluting clean fuel since the only combustion product is water and so its use would not lead to all environmental problems associated with burning fossil fuels.
 - It would be ideal if it could be manufactured by electrolysis of water eg using solar cells.
 - Hydrogen can be used to power **fuel cells** on the "Extra Electrochemistry" page.

n-butane

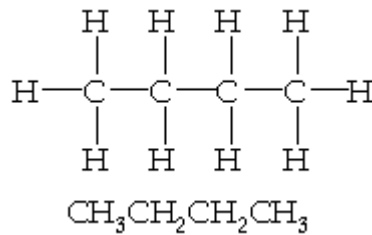

n-butane

Isobutane

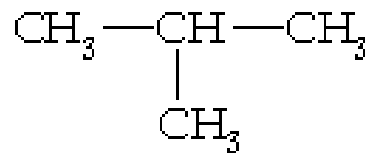
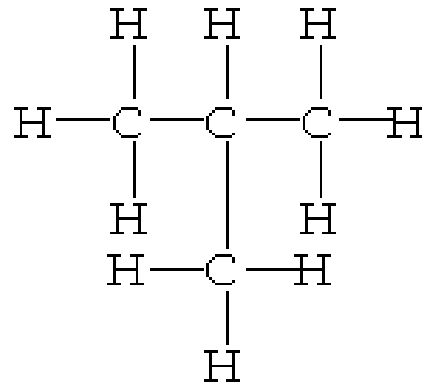

Isobutane

Neopentane

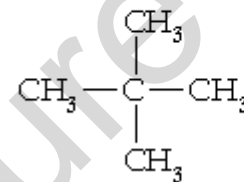
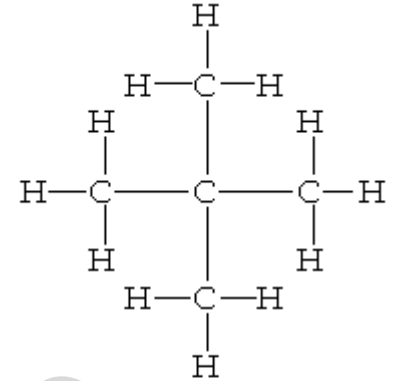

Neopentane

Isopentane

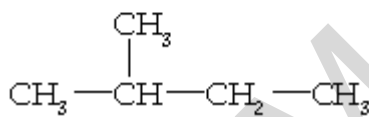
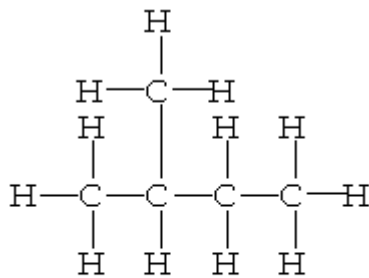

Isopentane

n-pentane

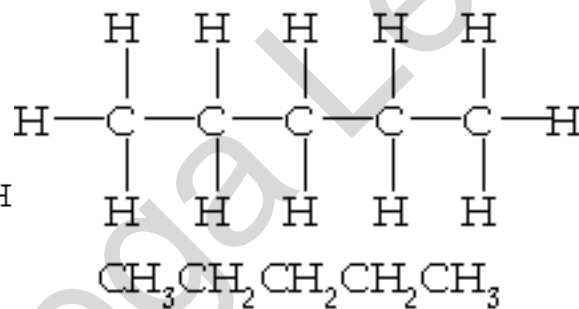

n-pentane

Extra GCSE ORGANIC CHEMISTRY

including introductory aspects of food and drug chemistry



on other pages .. [[basic Oil Products notes - if not on this page](#)] [[enzymes](#)] and on this page .. [[1. combustion](#)] [[2. alkane/alkene 'families'](#)] [[3. alcohols like ethanol](#)] [[4. other organic molecule families eg carboxylic acids, esters, polymers](#)] [[5. Natural molecules - carbohydrates, sugars, amino acids, proteins, fats, oils etc.](#)] [[6. Vitamin C, Drugs and Food Additives](#)] [[7. CFC's, Ozone and free radicals](#)] [[multiple choice quiz - still under development](#)] and [[email query or comment](#)]

KEYWORDS: .. [addition](#)(alkene reactions) .. [alcohols](#) .. [alkanes](#) .. [alkenes](#) .. [amino acids](#)(from hydrolysis) .. [analgesics](#) .. [aspirin \(soluble/insoluble/action\)](#) .. [carbohydrates](#) .. [carboxylic acids](#) .. [cellulose](#) .. [CFC's](#) .. [colourings](#) .. [combustion](#) .. [cracking](#) .. [disaccharide](#) .. [drugs](#) .. [E numbers](#) .. [esters](#) .. [ethanoic acid](#) .. [ethanol](#) .. [fats \(saturated/unsaturated\)](#) .. [fibre](#) .. [flavourings](#) .. [food additives](#) .. [fractional distillation](#) .. [free radicals](#) .. [fuel](#) .. [glucose](#) .. [glycerol](#) .. [glycine](#) .. [homologous series](#) .. [hydrolysis](#)(starch, protein, fats) .. [ibuprofen](#) .. [isomerism/isomers](#) .. [macromolecule](#) .. [margarine](#) .. [monosaccharide](#) .. [Nylon](#) .. [oils \(and fats\)](#) .. [organic](#) .. [ozone](#) .. [paracetamol](#) .. [plastics/polymers \(burning, structure\)](#) .. [polyamide](#) .. [polypeptides](#) .. [polysaccharides](#) .. [proteins](#) .. [preservatives](#) .. [saturated](#) .. [soaps](#) .. [starch](#) .. [sucrose](#) .. [sugars](#)(from hydrolysis, cyclic structure) .. [sweeteners](#) .. [Terylene](#) .. [thermosoftening](#) .. [thermosetting](#) .. [triglycerides](#) .. [unsaturated](#) .. [vinegar](#) .. [vitamin C](#) .. [[email comment or query](#)]

1. What is produced when organic compounds are burned?

Some organic compounds are used as fuels. Other organic compounds, including plastics, are burned as waste. Burning these organic compounds releases gases into the atmosphere.

- **All organic compounds consist partly of carbon atoms. Coal, crude oil, natural gas (methane) and wood contain organic compounds**
 - all are used as fuels, either directly like coal or natural gas,
 - or indirectly as coke from coal or petrol from crude oil etc.,
 - and apart from wood, they are finite (limited reserve) fossil (from decayed organic material) fuels.
- **Many hydrocarbons are fuels** ie a substance burned to release heat energy.
- **When organic compounds are burned in a plentiful supply of air the carbon is oxidised to carbon dioxide and the hydrogen is oxidised to water.**
- In a limited supply of air **incomplete combustion** occurs forming carbon monoxide and/ or carbon. Carbon monoxide is poisonous because it reduces the capacity of blood to carry oxygen.
- **Combustion equations and tests for combustion products** are all on the [Oil Notes](#) web page.
- Each fossil fuel has a different cost, efficiency and cleanliness on burning. Generally speaking in '**cleanliness**' the order is **methane (natural gas) > alkanes in petrol > heavy oil** and from **left to right there is also an increase in C/H atom ratio in the molecule so more CO₂ produced too**. Some [notes on other fuels](#) (but they are designed for more advanced level courses) and a [fossil fuel survey](#) on Oil Products Notes page
- **The combustion of plastics** (and other organic compounds) which contain chlorine and nitrogen produce poisonous fumes when burnt eg choking hydrogen chloride HCl and toxic hydrogen cyanide HCN respectively. Especially where there is a limited supply of air. The combustion products of carbon (toxic CO and CO₂) and hydrogen (H₂O) are also formed.
- **Hydrogen gas can be used as fuel.**
 - It burns with a pale blue flame in air reacting with oxygen to be oxidised to form water.
 - **hydrogen + oxygen ==> water** or $2\text{H}_{2(g)} + \text{O}_{2(g)} ==> 2\text{H}_2\text{O}_{(l)}$
 - It is a non-polluting clean fuel since the only combustion product is water and so its use would not lead to all environmental problems associated with burning fossil fuels.
 - It would be ideal if it could be manufactured by electrolysis of water eg using solar cells.
 - Hydrogen can be used to power [fuel cells](#) on the "Extra Electrochemistry" page.

2. Why are there families of organic compounds?

[alkanes and alkenes are introduced on the [Oil Notes page](#) and give details of (i) alkane combustion (ii) the reaction of bromine with alkenes and (iii) the basics of alkene polymerisation]

2a INTRODUCTION

Organic compounds belong to different families. The compounds in each family have a similar chemical structure and a similar chemical formula. Each family of organic compounds forms what is called a **homologous series**. Different families arise because carbon atoms readily join together in chains (catenation) and strongly bond with other atoms such as hydrogen, oxygen and nitrogen. The result is a huge variety of '**organic compounds**'. The **name** comes from the fact that most of the original organic compounds studied by chemists came from plants or animals.

- A **homologous series** is a family of compounds which have a **general formula*** and have **similar chemical properties because they have the same functional group** of atoms (eg C=C alkene, C-OH alcohol or -COOH carboxylic acid).
 - * **Match the general formula pattern with the alkane and alkene examples shown below.**
- **members of a homologous series** have similar physical properties such as appearance, melting/boiling points, solubility etc. but show trends in them eg steady increase in melting/boiling point with increase in carbon number or molecular mass.
- The **molecular formula** represents a summary of all the atoms in the molecule ([see examples below](#)).
- The structural or displayed formula shows the full structure of the molecule with all the individual bonds and atoms shown (though there are different 'sub-styles' of varying detail, see below).

2b ALKANES

- These are **obtained directly from crude oil by fractional distillation** ([see oil notes](#)).
- The **saturated hydrocarbons** form an homologous series called **alkanes** with a general formula C_nH_{2n+2}
- **Saturated means the molecule has no C=C double bonds, only carbon-carbon single bonds, and so has combined with the maximum number of atoms** ie no atoms can add to it. The alkanes don't really have a functional group and have quite a limited chemistry BUT they are still a clearly defined homologous series.
- **Alkane examples:** The gases: methane CH_4 , ethane C_2H_6 , propane C_3H_8 , butane C_4H_{10} , liquids: pentane C_5H_{12} , hexane C_6H_{14} etc. The first four alkane structures are shown on the [oil notes page](#). **Names end in ...ane**
- Carbon always forms 4 bonds with other atoms and hydrogen 1 bond with other atoms eg **Propane:** molecular formula C_3H_8 , structural and displayed formula styles include ...

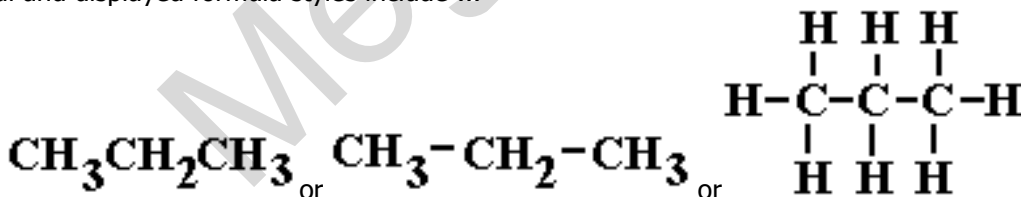

- **Isomerism** occurs when two or more compounds have the same chemical formula but have different structures. eg for the **molecular formula C_4H_{10}** there are two possibilities - one '**linear**' and one with carbon chain '**branching**' ...

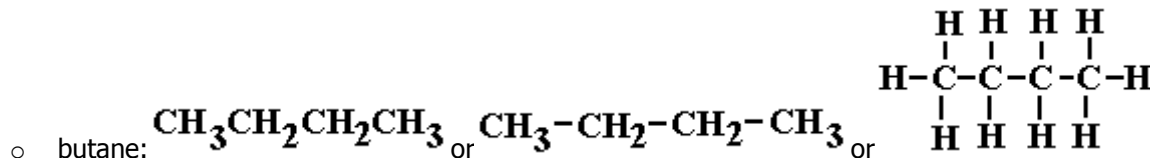

- $(\text{CH}_3)_3\text{CH}$ or $\text{CH}_3-\overset{\text{H}}{\underset{\text{CH}_3}{\text{C}}}-\text{CH}_3$ or $\begin{array}{c} \text{H} & \text{H} & \text{H} \\ | & | & | \\ \text{H}-\text{C}-\text{C}-\text{C}-\text{H} \\ | & | & | \\ \text{H} & & \text{H} \\ | & & | \\ \text{H}-\text{C}-\text{H} \\ | \\ \text{H} \end{array}$
- and its isomer **methylpropane**:
 - Can you work out the structures of the 3 isomers of C_5H_{12} ? (you will find enough to work out the answers on the advanced level page [ALKANES](#))
 - **Isomers show variation in physical properties** which depend upon the strength of the intermolecular forces. Intermolecular forces are due to weak electrical attractive forces that exist between all molecules.
 - (a) For a homologous series the strength of intermolecular forces increases as the carbon chain length increases
 - (b) For isomers (same C number), the forces decrease as the amount of chain branching increases.
 - This is because the attractive forces are a function of the potential surface-surface contact i.e. the compactness of the molecules.
 - (a) as the chain length increases the surface-surface contact must increase per molecule,
 - (b) for isomers, with more branching, the chain length decreases and the molecule is more 'compact' reducing the surface-surface contact per molecule.
 - For example ...
 - (a) from methane ==> ethane ==> propane ==> petrol ==> oils ==> grease ==> waxes etc. the boiling point rises and so does the viscosity (stickiness!) as the carbon chain length increases (trend also indicated by gases ==> liquids ==> solids).
 - (b) 'linear' butane has a higher boiling point than 'branched' methylpropane (diagrams above).
 - **Alkanes and alkenes undergo combustion reactions** ([see Oil](#)).
 - **They are not very reactive unless burned!** BUT they will react with strong oxidising chemicals like **chlorine** when heated or subjected to uv light (you need something to initiate the reaction).
 - A **substitution** reaction occurs and a chloro-alkane is formed eg
 - a hydrogen is swapped for a chlorine and the hydrogen combines with a chlorine atom
 - ethane + chlorine ==> chloroethane + hydrogen chloride
 - $\text{C}_2\text{H}_6 + \text{Cl}_2 \Rightarrow \text{C}_2\text{H}_5\text{Cl} + \text{HCl}$

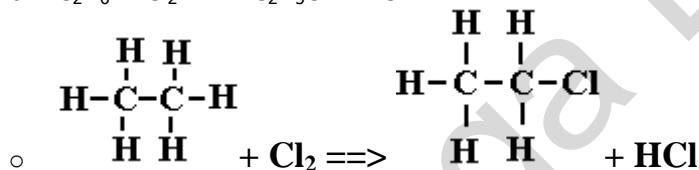

2c ALKENES

- These **cannot be obtained directly from crude oil** and **must be made by cracking** ([see oil notes](#)).
- The **unsaturated hydrocarbons** form an homologous series called **alkenes** with a general formula C_nH_{2n} **Unsaturated means the molecule has a C=C double bond to which atoms or groups can add.**
- **Alkene examples: Names end in ...ene**

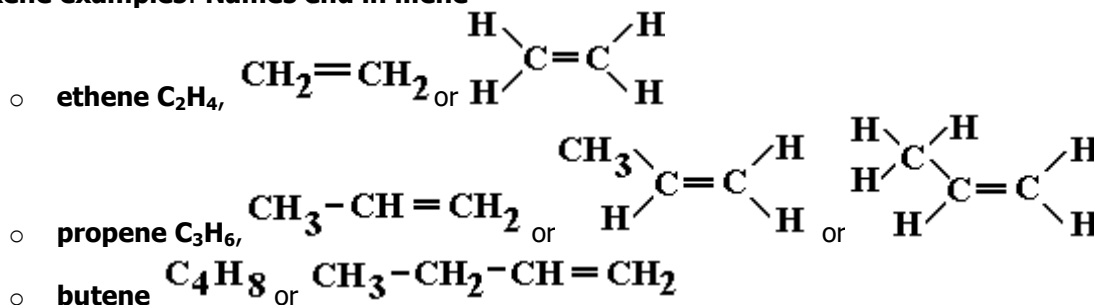

- **The alkenes are more reactive than alkanes** because of the presence of the carbon=carbon double bond. The **alkenes undergo addition reactions** in which one of the carbon=carbon double bonds breaks allowing each carbon atom to form a covalent bond with another atom such as hydrogen or bromine.
- **Examples of addition reactions are: with hydrogen** under pressure and in the presence of a **nickel catalyst** to form an

alkane

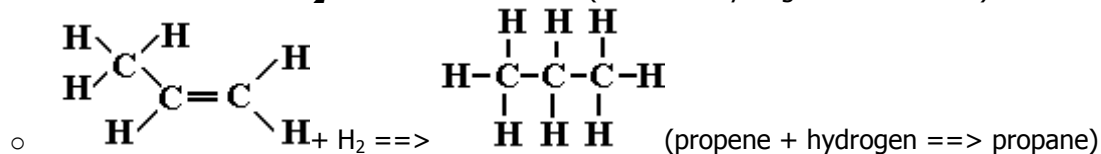
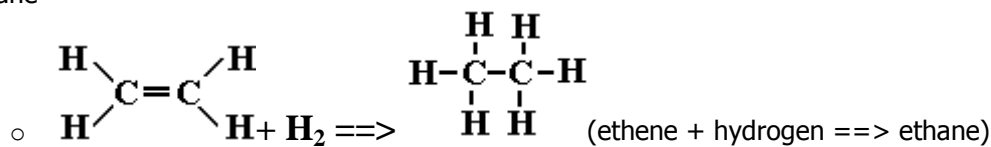

- Alkenes react by 'addition' with bromine and decolourises the orange bromine water because the organic product is colourless, and this is a simple test to distinguish an alkene from an alkane.
 - see [Oil Notes for equations for ethene and propene](#)
- Vegetable oils contain unsaturated fats and can be hardened to form margarine by adding hydrogen on to some of the carbon=carbon double bonds using a nickel catalyst.
- Alkenes can add to themselves by addition polymerisation to form 'plastic' or polymeric materials ([see below](#) or [oil notes](#))
- Alkenes are isomeric with cycloalkanes eg C₆H₁₂ can be hexene or cyclohexane

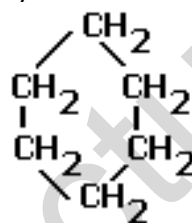

- hexene CH₃-CH₂-CH₂-CH₂-CH=CH₂ or cyclohexane
- and note that ...
 - hexene is an unsaturated hydrocarbon with a double bond,
 - the isomeric cyclohexane does not have a double bond and is a saturated hydrocarbon,
 - so a simple bromine test could distinguish the two similar colourless liquids,
 - because only the hexene would decolorise the bromine water test reagent.

3. What is ethanol and how can we make it?

What we call **alcohol in everyday life** is a substance whose **chemical name is ethanol**. Ethanol is just one member of a family of substances called **alcohols** which have a C-OH functional group in their structure.

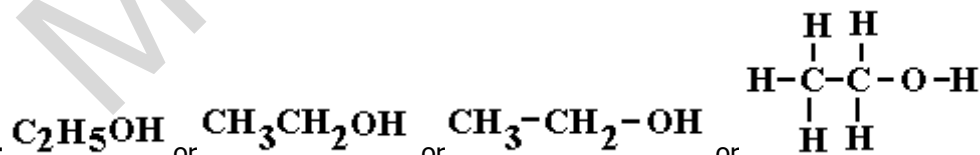

- Ethanol structure:** C₂H₅OH or CH₃CH₂OH or CH₃-CH₂-OH or
- Ethanol is used as a solvent**, as a **fuel** (can be mixed with petrol), and used to make '**ethyl esters**' ([see below](#)) as well as the 'potent' chemical present in alcoholic drinks!
 - The % alcohol in wines, spirits and beer varies from 1-40%
 - There are health and social issues about the medical and behavioral aspects of alcohol consumption.
 - Methylated spirit** is **mainly ethanol** but poisonous and nasty tasting chemicals like **methanol** are added so it is not used as a beverage!
- Ethanol can be produced by fermentation of sugars.** The raw materials are mixed with water and yeast at just above room temperature. The yeast contains enzymes which are biological catalysts. The sugars react to form ethanol and carbon dioxide. The carbon dioxide is allowed to escape and air is prevented from entering the reaction vessel to stop oxidation of ethanol to ethanoic acid ('acetic acid' or vinegar!). When the reaction is over the ethanol is separated from the reaction mixture by **fractional distillation**.
 - eg **glucose** ==enzyme==> **ethanol + carbon dioxide**

- o $C_6H_{12}O_{6(aq)} \implies 2C_2H_5OH_{(aq)} + 2CO_{2(g)}$
- o Ethanol, from a solution made from fermented sugar cane, can be concentrated by fractional distillation. In Brazil it is blended with petrol to give an alternative motor vehicle fuel.
 - $C_2H_5OH_{(l)} + 3O_{2(g)} \implies 2CO_{2(g)} + 3H_2O_{(l)}$
- The **alcohols form an homologous series** with the **functional group C-OH**. It is the presence of this functional group that gives alcohols their characteristic properties. The simplest homologous series of alcohols have the **general formula $C_nH_{2n+1}OH$** eg
- Ethanol is shown above and the simplest, lowest carbon number one, is **methanol** (shown below)

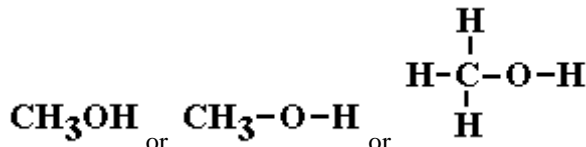

- o **All the alcohols are flammable colourless liquids with a not un-pleasant odour?**
- o **They all behave chemically in the same way but the boiling point steadily rises with increase in molecule size.**
- The next two are called propanol and butanol, the names end in ...ol

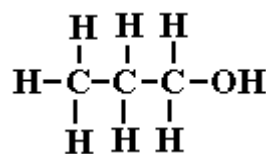

- o $CH_3-CH_2-CH_2-OH$ or and $CH_3-CH_2-CH_2-CH_2-OH$
- **Alcohols react, reversibly, with carboxylic acids to form esters** and water. Ethyl ethanoate is formed by the reaction of ethanoic acid with ethanol eg

- o **ethanoic acid + ethanol \rightleftharpoons ethyl ethanoate + water**

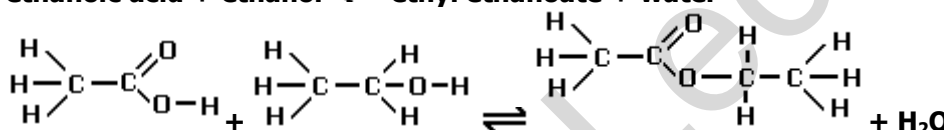

- o its an **equilibrium, 2/3rds conversion**, and **catalysed** by a few drops of **concentrated sulphuric acid**
- **Alcohols react with sodium to form hydrogen.**
 - o normal fizzing is observed and the salt product is soluble in the alcohol itself.
 - o eg ethanol + sodium \implies sodium ethoxide + hydrogen
 - o $2C_2H_5OH + 2Na \implies 2C_2H_5O^-Na^+ + H_2$
- **Ethanol can be produced by the reaction of steam and ethene** in the presence of a strong acid catalyst (Phosphoric acid). The reversible reaction is carried out at a moderately high temperature (eg 300°C) and a high pressure (eg 60 x atmospheric pressure). The higher temperature and catalyst speed up the reaction and increasing pressure moves the equilibrium to the right (side least gaseous molecules at 300°C)

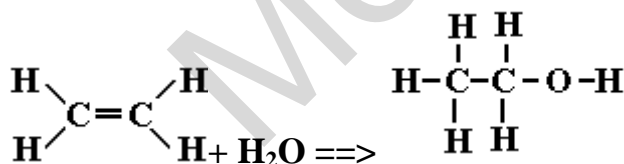

- **Advantages and disadvantages of the two methods of making ethanol:**
 - o **advantages of fermentation:** cheap and renewable resource like sugar cane (Brazil), sugar beet
 - o **disadvantages of fermentation:** slow reaction and made by an inefficient batch process, poor quality product eg low aqueous concentration, other organic chemicals formed to and yeast cell residues to remove .
 - o **advantages of ethene route:** fast and efficient continuous process, relatively pure product, country may have local oil supply (eg North Sea for UK, Middle East countries)
 - o **disadvantages of ethene route:** using a non-renewable finite resource (crude oil/cracking)
- **Ethanol can be oxidised to form ethanoic acid** which is a useful organic chemical. BUT it is this oxidation of ethanol that results in alcoholic drinks turning sour (eg cider, wine) when exposed to air. Ethanoic acid (old name 'acetic acid') is the basis of vinegar and is also used in making esters (eg pear drop essence, or .

- $$\begin{array}{c} \text{H} & & \text{H} \\ & \diagdown & / \\ & \text{C} - & \text{C} - \text{O} - \text{H} \\ & / & \diagdown \\ \text{H} & & \text{H} \end{array} + \text{O}_2 \Rightarrow \begin{array}{c} \text{H} & & \text{O} \\ & \diagdown & // \\ & \text{C} - & \text{C} - \text{O} - \text{H} \\ & / & \diagdown \\ \text{H} & & \text{H} \end{array} + \text{H}_2\text{O}$$
- This **oxidation can also be done by heating the ethanol with a mixture of sulphuric acid and potassium dichromate(VI) solution**. The mixture turns from orange to green.
 - When burned, ethanol, like any alcohol, forms carbon dioxide and water
 - $\text{CH}_3\text{CH}_2\text{OH} + 2\text{O}_2 \Rightarrow 2\text{CO}_2 + 3\text{H}_2\text{O}$
 - Ethanol can be dehydrated to ethene** by passing the alcohol vapour over **heated aluminium oxide catalyst**.

$$\begin{array}{c} \text{H} & \text{H} \\ | & | \\ \text{H} - \text{C} - & \text{C} - \text{O} - \text{H} \\ | & | \\ \text{H} & \text{H} \end{array} \Rightarrow \begin{array}{c} \text{H} & & \text{H} \\ & \diagdown & / \\ & \text{C} = & \text{C} \\ & / & \diagdown \\ \text{H} & & \text{H} \end{array} + \text{H}_2\text{O}$$
 - This reaction is potentially an important source of organic chemicals eg plastics from a renewable resource since the ethanol can be made by fermentation of carbohydrates etc.
 - Alcohols from propanol upwards, ie from carbon number 3 or greater, will form isomers.**
 - You will find plenty of examples on the [advanced organic chemistry page for alcohols](#).
 - The steroid, **cholesterol**, contains the **alcohol group -OH**. Cholesterol is an essential steroid to humans but if too much is produced it can cause heart disease.
 - <http://webbook.nist.gov/cgi/cbook.cgi?Name=cholesterol&Units=SI> gives the **skeletal formula structure of cholesterol** (this structure representation is only dealt with at advanced level). All the lines in the structure represent bonds between carbon atoms except the 'dash' for the -OH alcohol group in the bottom right of the molecule. Also note the 'alkene' double bond functional group to the right of the -OH group.

4. What other families of organic compounds are there?

4a. The acids that we find in fruits and in vinegar belong to a homologous series called **carboxylic acids** and many fragrances and food additives are **esters**.

4b. **Polymers** do not form a homologous series but they are all organic compounds having very long molecules.

4a. CARBOXYLIC ACIDS and ESTERS

- Carboxylic acids** form another homologous series and have the functional group **-COOH**.
- The structures of the first three members are given below: **Names end in ...oic acid**.
 - methanoic acid:** HCOOH or $\begin{array}{c} \text{O} \\ // \\ \text{H} - \text{C} \\ | \\ \text{OH} \end{array}$ or $\begin{array}{c} \text{O} \\ // \\ \text{H} - \text{C} - \text{O} - \text{H} \end{array}$
 - ethanoic acid:** CH_3COOH or $\begin{array}{c} \text{O} \\ // \\ \text{CH}_3 - \text{C} \\ | \\ \text{OH} \end{array}$ or $\begin{array}{c} \text{H} & \text{O} \\ | & // \\ \text{H} - \text{C} - & \text{C} - \text{O} - \text{H} \\ | & \diagdown \\ \text{H} & \end{array}$
 - propanoic acid:** $\text{CH}_3\text{CH}_2\text{COOH}$ or $\begin{array}{c} \text{O} \\ // \\ \text{CH}_3 - \text{CH}_2 - \text{C} \\ | \\ \text{OH} \end{array}$ or $\begin{array}{c} \text{H} & \text{H} & \text{O} \\ | & | & // \\ \text{H} - \text{C} - & \text{C} - & \text{C} - \text{O} - \text{H} \\ | & | & \diagdown \\ \text{H} & & \end{array}$
- Vinegar** contains ethanoic acid (old name 'acetic acid'), see above in section 3 Alcohols above. It is used as a preservative and in food flavourings.
- Ethanoic acid is used in the manufacture of the fibre, acetate rayon.**
- Oranges, lemons and many soft drinks contain a carboxylic acid eg citric acid.**
- Aspirin is a carboxylic acid.** Aspirin is a drug used for pain relief and is taken regularly by those at risk from heart attacks.
- Ascorbic acid (vitamin C) is another carboxylic acid** and is present in fresh fruit and vegetables.
- Carboxylic acids are weak acids**, typically solutions are around pH3 (yellow-orange-pink with universal indicator).

- o [theory on [Extra Aqueous Chemistry page](#) look for keywords]
- **They react and are neutralised by ...** with examples ...
 - o **metals** to form salts and hydrogen
 - ethanoic acid + magnesium ==> magnesium ethanoate + hydrogen
 - $2\text{CH}_3\text{COOH} + \text{Mg} \Rightarrow (\text{CH}_3\text{COO})_2\text{Mg} + \text{H}_2$
 - o **alkali bases** to form a carboxylic acid salt and water eg ...
 - eg ethanoic acid + potassium hydroxide ==> potassium ethanoate + water
 - $\text{CH}_3\text{COOH} + \text{KOH} \Rightarrow \text{CH}_3\text{COOK} + \text{H}_2\text{O}$
 - o **carbonate and hydrogencarbonate bases** to produce a carboxylic acid salt, water and carbon dioxide eg ...
 - eg ethanoic acid + sodium hydrogen carbonate ==> sodium ethanoate + water + carbon dioxide
 - $\text{CH}_3\text{COOH} + \text{NaHCO}_3 \Rightarrow \text{CH}_3\text{COONa} + \text{H}_2\text{O} + \text{CO}_2$
 - OR propanoic acid + sodium carbonate ==> sodium propanoate + water + carbon dioxide
 - $2\text{CH}_3\text{CH}_2\text{COOH} + \text{Na}_2\text{CO}_3 \Rightarrow 2\text{CH}_3\text{CH}_2\text{COONa} + \text{H}_2\text{O} + \text{CO}_2$
- **Carboxylic acids react with alcohols** to form members of another homologous series called **esters**. Concentrated sulphuric acid acts as a catalyst in this reaction. See the [formation of ethyl ethanoate](#) above in section 3. above.

$$\begin{array}{c} \text{H} \\ | \\ \text{H}-\text{C}-\text{C}=\text{O} \\ | \quad \quad | \\ \text{H} \quad \quad \text{O} \end{array} - \begin{array}{c} \text{H} \\ | \\ \text{C}-\text{H} \\ | \\ \text{H} \end{array} \quad \text{and} \quad \begin{array}{c} \text{O} \\ || \\ \text{CH}_3-\text{C}-\text{O}-\text{CH}_2-\text{CH}_2-\text{CH}_3 \end{array}$$

 - o show the structures of other esters made from ethanoic acid: namely methyl ethanoate using methanol, and propyl ethanoate from propyl alcohol
 - o and what would the structure of their original alcohols be and what would the structure of butyl ethanoate be?
- **Esters are usually sweet smelling and widely used as fragrances (eg perfumes) and food flavourings.**

4b. POLYMERS - synthetic macromolecules

- Some **basic notes on polymers and plastics** in the [Oil Products Notes](#).
- Some important structure, strength and 1D to 3D dimension concepts) in the "[Chemical Bonding](#)" notes.
- **Most polymers (plastics) are made from alkene compounds containing the -C=C- bond by addition polymerisation.**
- Poly(chloroethene) is made from chloroethene (old name 'vinyl chloride'), $\text{CH}_2=\text{CHCl}$ but the polymer is generally called polyvinylchloride, PVC. The general equation and the formation of poly(ethene) and poly(propene) are shown on the [Oil notes](#) page. The formation of PVC is shown below.

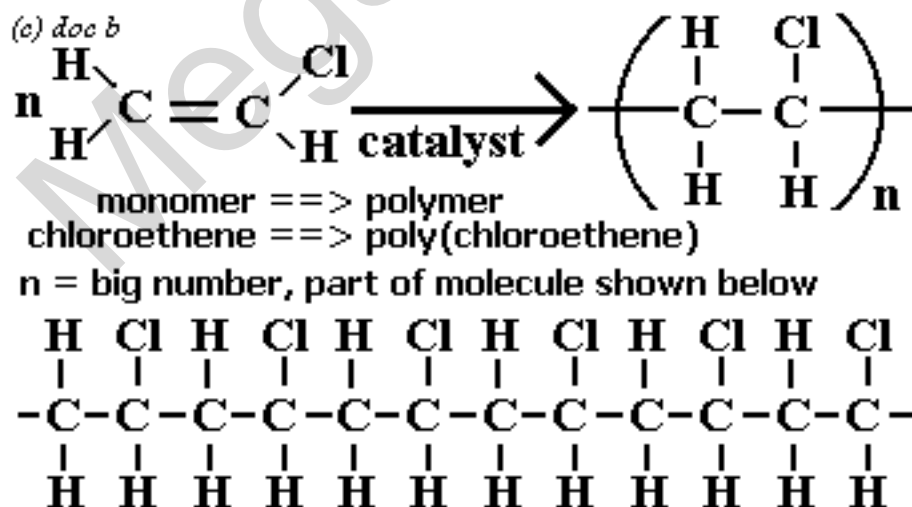

- **Polymers (plastics) consist of a tangled mass of very long molecules** in which the atoms are joined by strong covalent bonds to form long chains, but there are much weaker intermolecular forces holding the material together.
- In **thermosoftening plastics** like poly(ethene), poly(propene) or poly(chloroethene) PVC, because the inter-molecular attractive forces between the chains are weak, the plastic softens when heated and hardens again when cooled. It also means the polymer molecules can slide over each other. This means they can be easily stretched or moulded into any desired shape.

- However it is possible to manufacture and process plastics in which the polymer chains are made to line up. This greatly increases the intermolecular forces between the 'aligned' polymer molecules and strong **fibre** strands of the plastic can be made.
- Examples: The addition polymer **poly(propene)** and the condensation polymers **nylon** and **Terylene**
- When a **thermosetting plastic** is first heated covalent bonds are formed between adjacent chains of the polymers. These strong covalent cross-linkages give the material a high melting point and greatly increased strength and rigidity. They also prevent thermosetting plastics from being softened with heat and therefore from being stretched or re-shaped. However it does make a much stronger material and not as flammable. On heating strongly they do NOT melt, but tend to char, gradually giving off gases.



thermoplastic



fibre



thermoset

- **Melamine** (used in furniture) and many glues are examples of thermosetting polymers.
- **Problems with using plastics** are on the [Oil Products Notes](#) page.
- Some important structure, strength and 1D to 3D dimension concepts) in the "[Chemical Bonding](#)" notes.

4c. Other Synthetic Polymers - macromolecules

- **Condensation polymerisation** involves linking lots of small monomer molecules together by eliminating a small molecule. This is often water from two different monomers, a H from one monomer, and an OH from the other, the 'spare bonds' then link up to form the polymer chain.
- **Nylon (a polyamide)** is formed by **condensation polymerisation**, the structure of nylon represented as ... (the rectangles represent the rest of the carbon chains in each unit)

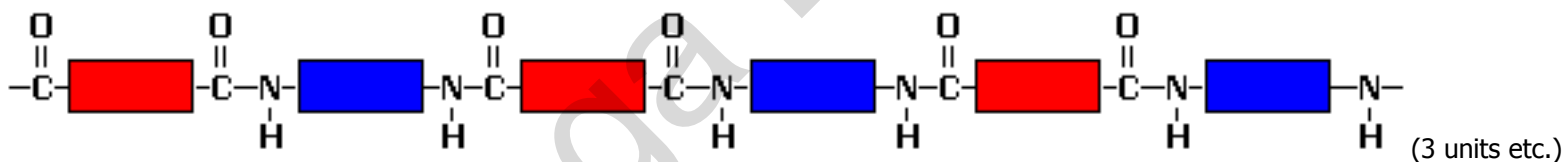

- This is the same linkage (-CO-NH-) that is found in linked amino acids in naturally occurring macromolecules called proteins, where it is called the 'peptide' linkage.
- **Terylene (a polyester)** is formed by **condensation polymerisation** and the structure of Terylene represented as

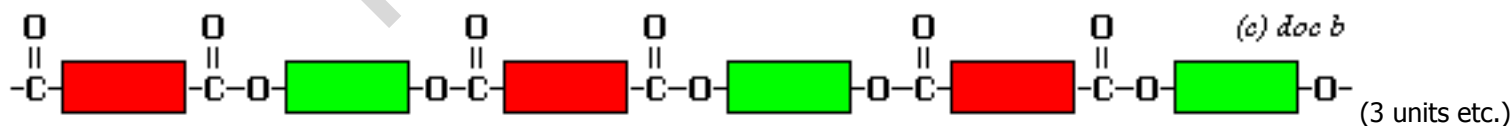

- This is the same kind of 'ester linkage' (-COOC-) found in fats which are combination of long chain fatty carboxylic acids and glycerol (alcohol with 3 -OH groups, a 'triol').
- **Terylene and nylon are good for making 'artificial' or 'man-made' fibres** used in the clothing and rope industries. In the manufacturing process the polymer chains are made to line up. This greatly increases the intermolecular forces between the 'aligned' polymer molecules and strong **fibre** strands of the plastic can be made.
- Some **important structure, strength and 1D to 3D dimension concepts** in "[Chemical Bonding](#)" notes.

5. Naturally Occurring Molecules

Small Molecules \rightleftharpoons Natural Polymers = Macromolecules

Carbohydrates, Proteins and Fats are the main nutrient constituents of food.

5a. Carbohydrates

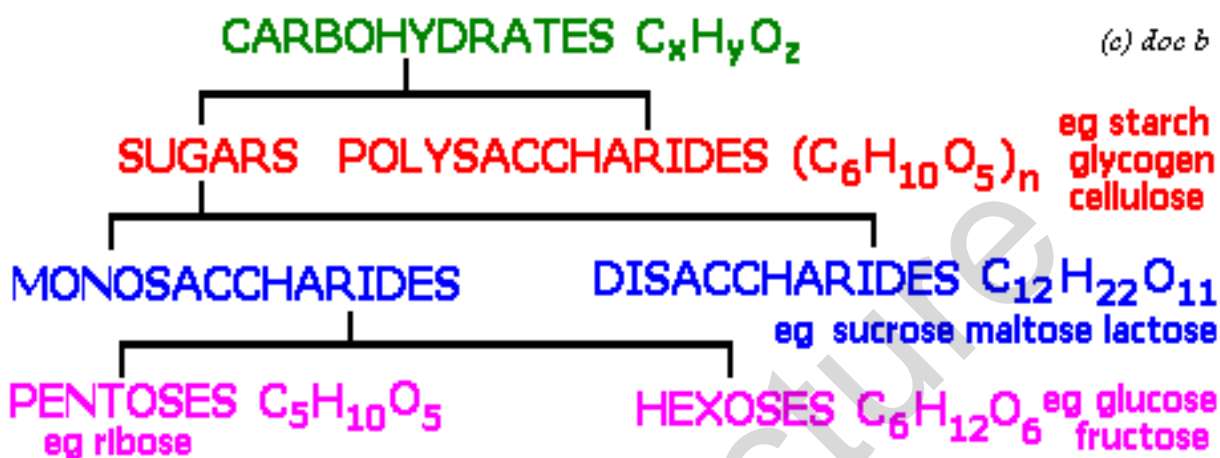

- **Carbohydrates** are a whole series naturally occurring molecules based on the elements carbon, hydrogen and oxygen.
- Historically the name 'carbohydrate' comes from the fact that all their formulae seemed to be based on $C_x(H_2O)_y$ (see key above) BUT this is not the way to think of their formula.
- They range from relatively **small molecules** called **monosaccharide** (means one basic unit), or **disaccharide** (two basic units combined) to **very large natural polymers or macromolecules** called **polysaccharides** (many units combined). A summary of them is shown in the **key diagram above** along with some **familiar names** from biology.

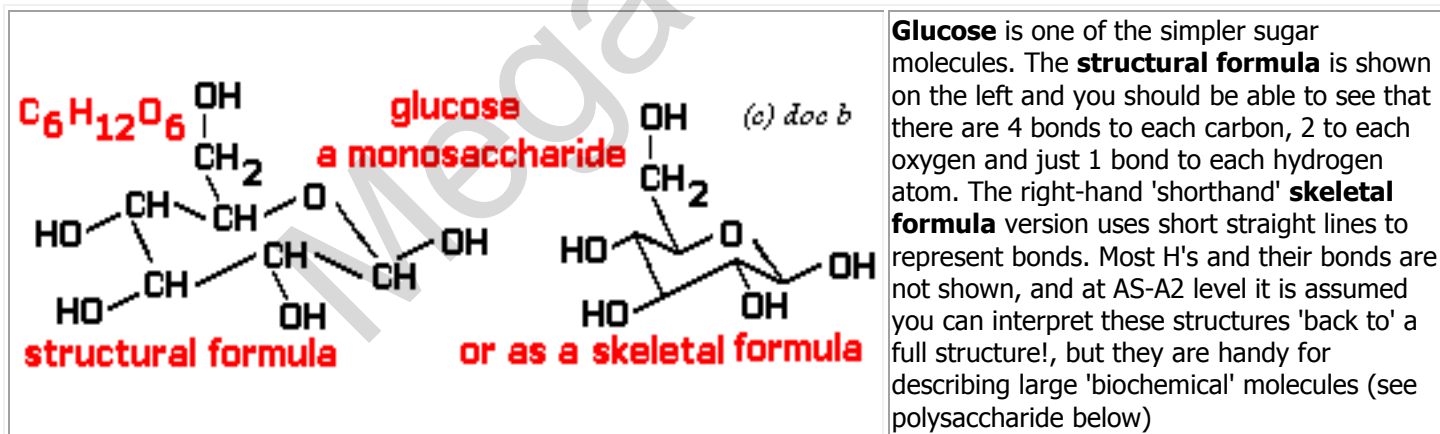

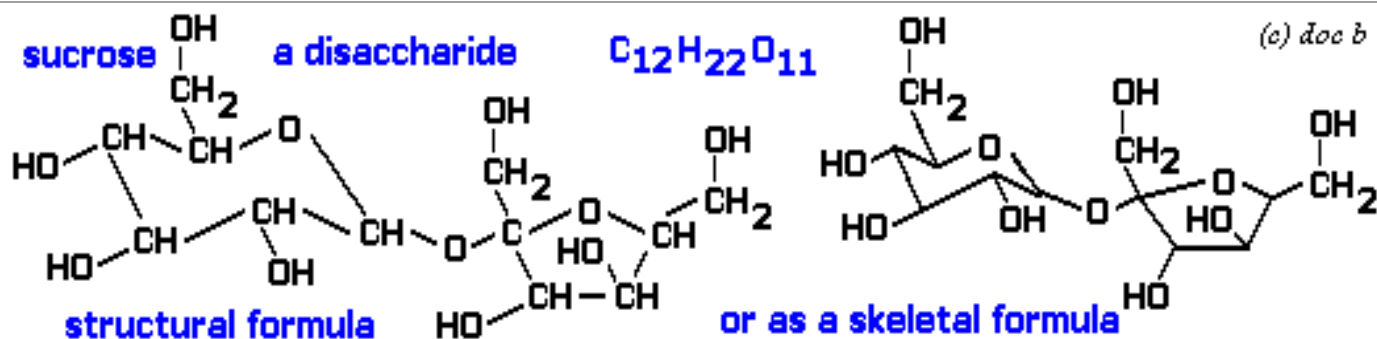

- **Sucrose** is a **disaccharide** made from combining two monosaccharide molecules, glucose and fructose by the elimination of a water.
 - On **hydrolysis** sucrose reforms the glucose and fructose.
 - $2C_6H_{12}O_6 \rightleftharpoons C_{12}H_{22}O_{11} + H_2O$

• **The formation of complex carbohydrates:**

- **These are made of smaller carbon, hydrogen and oxygen based molecules combining together eg starch and cellulose are formed from glucose, molecular formula $C_6H_{12}O_6$.**
- Their formation can be described in terms of a large number of sugar units joined together by **condensation polymerisation**
 - eg the 'box' diagram below shows 4 units of a natural carbohydrate polymer being formed
 - Note: Condensation polymerisation means the joining together of many small 'monomer' molecules by eliminating an even smaller molecule between them to form the linkage.
 - eg $HO-XXXXX-OH + HO-XXXXX-O-XXXXX-OH + H_2O$ etc.
- $n C_6H_{12}O_6 \Rightarrow (C_5H_{10}O_5)_n + nH_2O$ (where n is a very large number to form the natural polymer)
- The **XXXXX** or the **[rectangles]** below, represent the rest of the carbon chains in each unit (more detail in the 3rd diagram below).

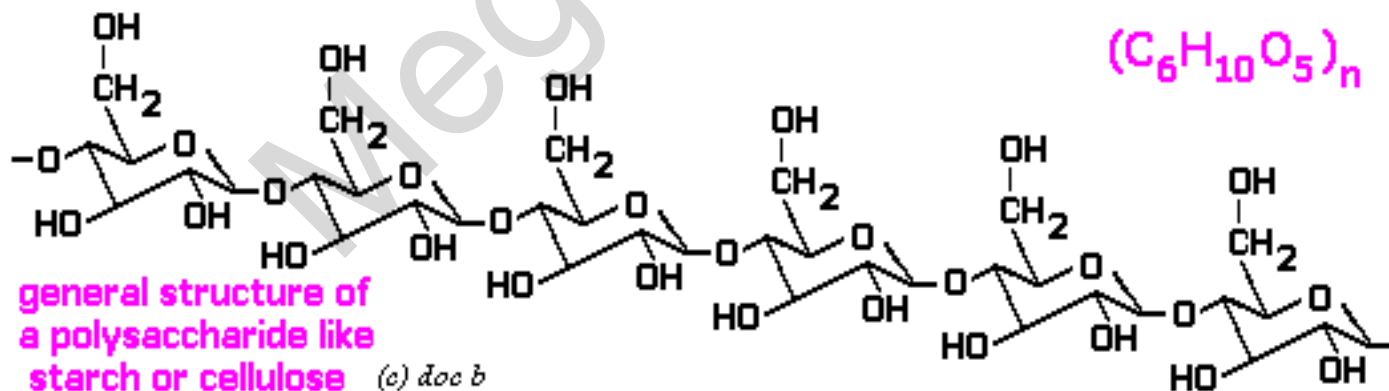
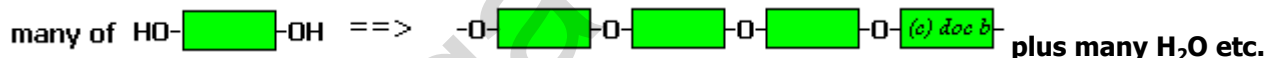

This **diagram of starch or cellulose** is in '**skeletal formula**' style and both are polymers of glucose - can you see the connection between each 'unit' and the structure of **glucose** itself?

- The resulting **natural polymer** is called a **polysaccharide**.
- **Acid hydrolysis of complex carbohydrates (eg. starch) gives simple sugars.**
 - This can be brought about by eg warming starch with hydrochloric acid solution to form glucose.
 - $(C_5H_{10}O_5)_n + nH_2O \Rightarrow n C_6H_{12}O_6$ (where n is a very large number)

- The **hydrolysis products from polysaccharides** can be analysed with **paper chromatography**.

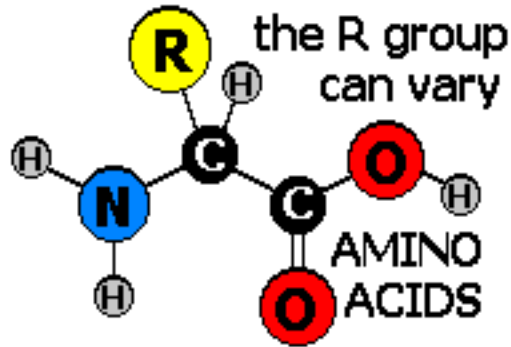

5b. Proteins and Amino Acids

- Amino acids** are carboxylic acids (like ethanoic acid) but one of the hydrogen atoms of the 2nd carbon atom is substituted with an **amino group** (a nitrogen + two hydrogens gives -NH_2). Another hydrogen on the same 2nd carbon can be substituted with other groups of atoms (R) to give a variety of amino acids.

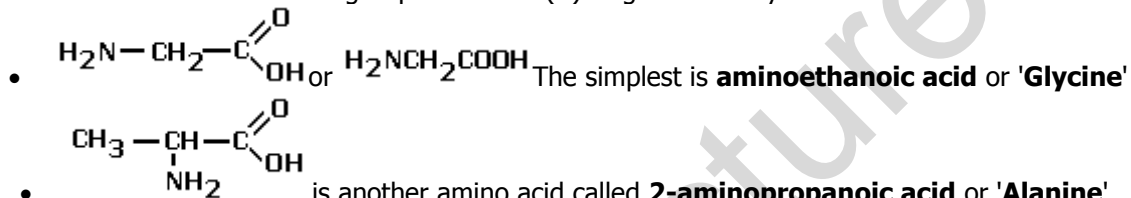

- All amino acids have the general structure $\text{H}_2\text{N}-\text{CH}(\text{R})-\text{COOH}$.**
 - R can vary, think of it as the '**Rest of the molecule!**'
 - R = H for Glycine, R = CH_3 for Alanine.
- They **polymerise together, by condensation polymerisation, forming proteins or polypeptides.**
 - The peptide linkage is formed by elimination of water between two amino acids.
 - $\text{H}_2\text{N}-\text{CH}(\text{R})-\text{COOH} + \text{H}_2\text{N}-\text{CH}(\text{R})-\text{COOH} \Rightarrow \text{H}_2\text{N}-\text{CH}(\text{R})-\text{CO}-\text{NH}-\text{CH}(\text{R})-\text{COOH} + \text{H}_2\text{O}$ etc. so ...
 - $n \text{ H}_2\text{N}-\text{CH}(\text{R})-\text{COOH} \Rightarrow \text{-NH}-\text{CO}-\text{CH}(\text{R})-\text{NH}-\text{CO}-\text{CH}(\text{R})-\text{NH}-\text{CO}-\text{CH}(\text{R})-\text{NH}-\text{CO}-\text{CH}(\text{R})-$ etc. n units long
 - So **proteins are condensation polymers of amino acids.**
- Proteins have the same (amide) linkages as nylon** but with different units.
- Proteins are an important component of tissue structure and enzymes are protein molecules.**
- When proteins are heated with aqueous hydrochloric acid or sodium hydroxide solution they are hydrolysed to amino acids.**
 - see **chromatography** below, about how amino acids are identified in proteins.

5c. Fats, Oils and Margarine

- Oils and Fats** are an important way of **storing chemical energy** in living systems and are also a **source of essential long-chain fatty acids**.
- Most of them are **esters of the tri-alcohol ('triol') glycerol** (systematic name propane-1,2,3-triol, but that can wait until AS-A2 level!).
- The carboxylic acids which combine with the glycerol are described as '**long-chain fatty acids**'.
- The resulting ester is called a 'triesther' or '**triglyceride**'.
- The 'long-chain fatty acids' can be saturated, with **no $\text{C}=\text{C}$ double bonds**, and so forming **saturated oils or fats** (1st diagram below of the triglyceride formed from **palmitic acid**).

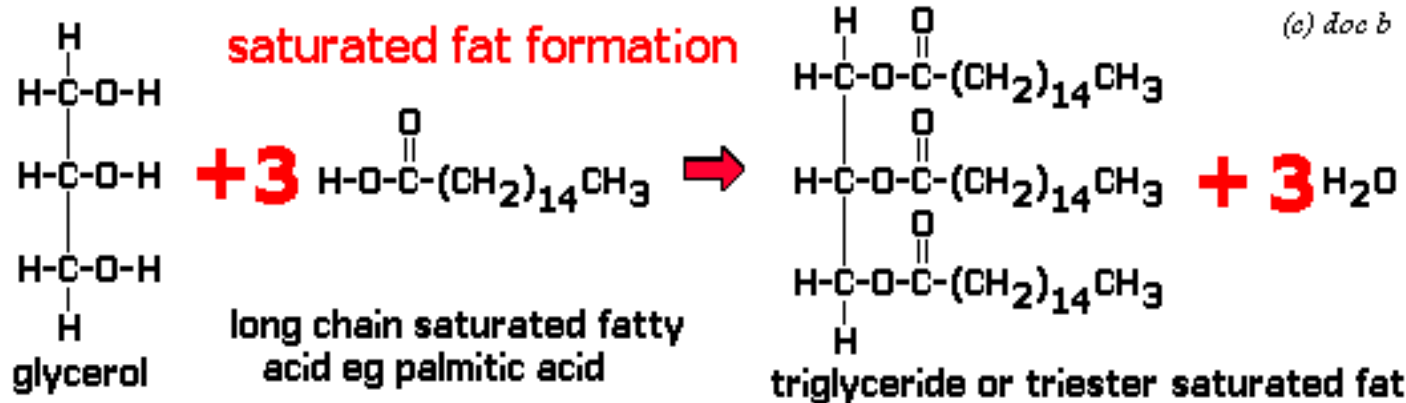

- The 'long-chain fatty acids' can be **unsaturated**, with **one or more C=C double bonds**, and so forming **unsaturated oils or fats** (2nd diagram below of the triglyceride formed from oleic acid).

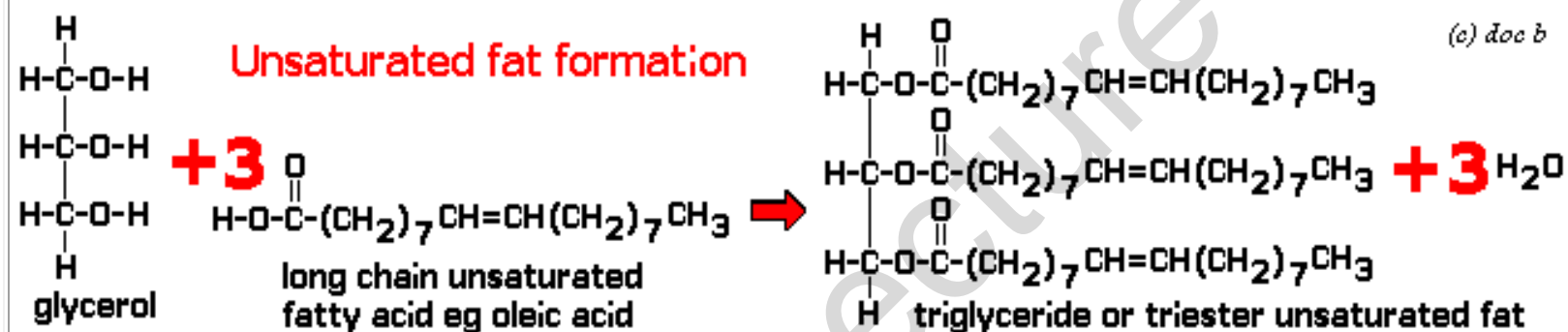

- Some sub-notes on Oil and Fat Structure:** (health issues dealt with further down)
 - They have the same linkages as Terylene but with different units.
 - They are not as big as polymer molecules, but a lot bigger than a single petrol or sugar molecule.
 - There can be **1 to 3 different saturated or unsaturated fatty acid components**, so lots of variation possible in structure of the oil or fat. The diagrams just assume three molecules of the same 'fatty' acid.
 - Monounsaturated fats have one C=C double bond** in them, **polyunsaturated fats usually have at least three C=C bonds** in their molecular structure.
 - For the same molecular size in terms of carbon number, **unsaturated fats have slightly lower intermolecular forces** because the C=C double bond produces a kink in the carbon chain and they can't pack as closely together as the saturated molecules.
 - This gives **unsaturated fats a lower melting point** and so they tend to occur as eg vegetable oils rather than saturated low melting solids from meat and dairy products.
 - However, this means these unsaturated oils are **not as conveniently 'spreadable'** as 'butter'.
 - To overcome this problem, '**margarine**' was invented. The vegetable oils are reacted with hydrogen using the gas and a nickel catalyst.
 - This reaction adds hydrogen atoms to the double bonds making a more saturated and more 'spreadable' solid fat we call '**margarine**'.
 - The reaction for any double bond is: $\text{>CH=CH<} + \text{H}_2 \xrightarrow{\text{Ni}} \text{-CH}_2\text{-CH}_2\text{-}$
 - BUT** it does mean that it is more like animal fat now but various blends have been developed to suit your dietary needs or desires!

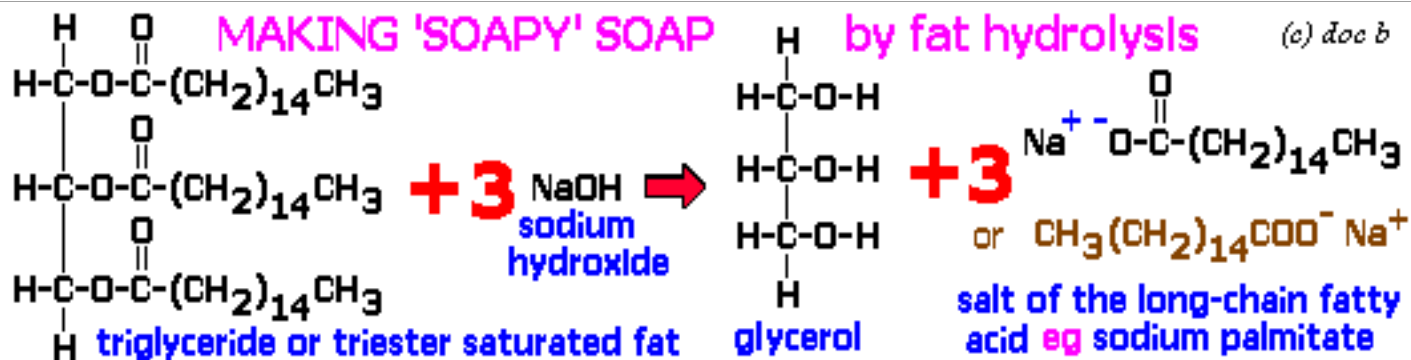

- **'Traditional' soap is a product of the hydrolysis of fats.**
 - 'Soapy' soaps (not modern detergents) are the sodium salts of long chain fatty acids formed by heating fatty oils with sodium or potassium hydroxide to hydrolyse them.
 - This reaction breaks the fat molecule down into one glycerol molecule (triol alcohol) and three sodium salts of the long chain carboxylic fatty acids.
- Since **fats and oils are important to our diet**, there is the ever present danger of over-consumption (speaking as someone who loves chips and spicy crisps!). So there are health and social, as well as 'molecular' issues to address!
 - We **need oils and fats as sources of important essential fatty acids.**
 - We **need both saturated and unsaturated fats or oils.**
 - The main sources of saturated fats are from meat and dairy products eg 'dripping' and butter.
 - The main sources of unsaturated fats are plant oils eg olive oil.
 - It is recommended that we do not overdo the fat intake but we do need both saturated and unsaturated fats.
 - However, too much saturated fat raises cholesterol levels and is not too good for the heart.
- **If you wish to know more about fats and oils there is plenty on the web! eg**
 - <http://www.healthnet.org.uk/diet/fatoil.htm>
 - <http://biology.clc.uc.edu/courses/bio104/lipids.htm>
 - <http://www.nutristrategy.com/fatsoils.htm>

5d. Chromatography

- **Hydrolysis** means breaking down a molecule with water to form two or more products.
 - Hydrolysis is **accelerated if the substance is heated with acid or alkali** solutions.
- **When proteins are heated with aqueous acid they are hydrolysed to amino acids.**
- **Acid hydrolysis of complex carbohydrates (eg. starch) gives simple sugars.**
- **Chromatography** is useful in separating and identifying the products of hydrolysis of carbohydrates and proteins.
 - The hydrolysis can be done by boiling the carbohydrate or protein with hydrochloric acid.
 - The hydrolysed mixture is then 'spotted' onto the pencil base line of the chromatography paper.
 - Known sugars or amino acids are also spotted onto the base line too.
 - The prepared paper is then placed vertically in a suitable solvent, which rises up the paper.
 - Since the products are colourless, the dried chromatogram is treated with another chemical to produce a coloured compound.
 - Ninhydrin produces purple spots with amino acids
 - and resorcinol makes coloured spots with sugars.
 - You can then tell which amino acids made up the protein or the sugars from which the carbohydrate was formed.
 - The number of different spots tells you how many different amino acids or sugars made up the natural macromolecule.
 - Spots which horizontally match the standard known molecule spots confirm identity.
 - **Starch** gives one spot because only **glucose** is formed on hydrolysis.
 - $(\text{C}_5\text{H}_{10}\text{O}_5)_n + n\text{H}_2\text{O} \Rightarrow n \text{C}_6\text{H}_{12}\text{O}_6$ (where n is a very large number)
 - More details on [chromatography](#).

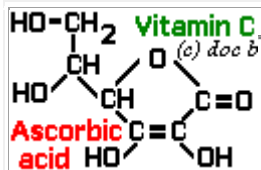

6. Vitamins, Drugs and Food Additives (NOT FINISHED)

- **Vitamins are particular essential molecules with particular roles in living systems** which are **NOT** proteins, carbohydrates, fats or mineral salts.
- One of the most important ones in any diet is **Vitamin C** or **Ascorbic Acid**. Its structure is related to 'simple' sugars but humans are one of the few mammals that are unable to synthesise vitamin C.
 - It is essential for healthy tissue and one of its functions is the removal of dangerously reactive chemical species called **free radicals** (see further on).
 - **Vitamin C is present in fruit and vegetables but the amount is reduced by prolonged storage and cooking..**
 - 250 years ago, as many as $\frac{2}{3}$ of a ship's crew died from vitamin C deficiency causing scurvy. In 1747 it was decided to give sailors citrus fruits to recover from scurvy but wasn't until 200 years later that vitamin C was recognised.
 - In contrast to the other water-soluble vitamins, vitamin C has no clear cut role as a catalyst or part of an enzyme. It does, however, have a range of other important functions:
 - Collagen formation. Vitamin C in collagen formation which is found wherever tissues require strengthening, especially in tissues with a protective, connective, or structural function. Collagen is critical to the maintenance of bone and blood vessels and is essential in wound healing.
 - Antioxidant activity. Ascorbic acid can act as an antioxidant by donating electrons and hydrogen ions, and reacting with reactive oxygen species or free radicals.
 - Iron absorption. Vitamin C is important for the effective absorption of iron and reduces iron(III) Fe^{3+} to iron(I) Fe^{2+} .
 - It helps in the synthesis of vital cell compounds. During times of physical and emotional stress, as well as during infection, there is increased production of oxygen radicals. Therefore there is increased reliance on vitamin C's activity as an antioxidant.
 - Vitamin C is vital for the function of the immune system, but the effectiveness of large doses of vitamin C in preventing and alleviating the symptoms of the common cold is still a matter of debate.
 - Two of the earliest signs of deficiency (prevention of collagen synthesis) relate to its roles in maintaining the integrity of blood vessels. The gums around the teeth bleed more easily, and the capillaries under the skin break spontaneously producing tiny haemorrhages. If you are short of vitamin C for say 20 days, scurvy can develop and is characterised by further haemorrhaging, muscles depletion, rough-brown-dry-scaly skin, deep bruising. Wounds fail to heal properly and bone fails to rebuild properly too and you are further likely to suffer from anaemia and infections.
 - **SO EAT yer fruit and veg 'guys' (as well as a few crisps!) AND keep yer health and still pass those dreaded exams!!!!**
- **Drugs** can be defined as an externally administered substances which modifies or affects chemical reactions in the body, usually for the bodies greater well-being. Poisons can be defined in the same way, but hopefully not intentionally and have undesired effects!
 - An **analgesic** is a drug used to reduce pain and is type of anti-inflammatory agent.
 - **The molecular structure of three well known analgesics are shown in the diagram below.**
 - All are used for 'headache' treatment, and hopefully using this website and others will help minimise their use!

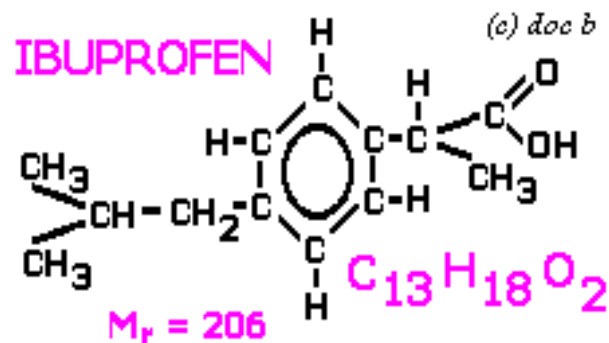
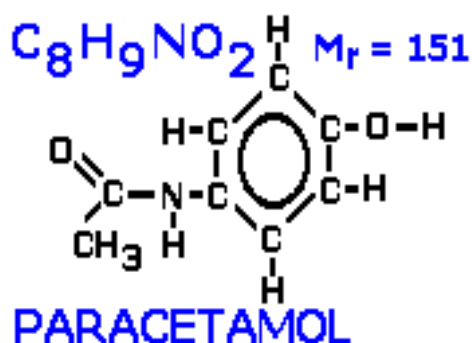

The central hexagonal ring of 6 carbon atoms is called a 'benzene' or 'aromatic' ring. The 4th outer electron of carbon (group 4) is delocalised, so the expected 4th bond per C atom forms part of a 'communal' system (more on this at advanced level, but the covalence rule of 4 for carbon is not broken!, you have seen this situation before, check out [graphite](#)). You can show a benzene ring as a simple hexagon with a circle in it

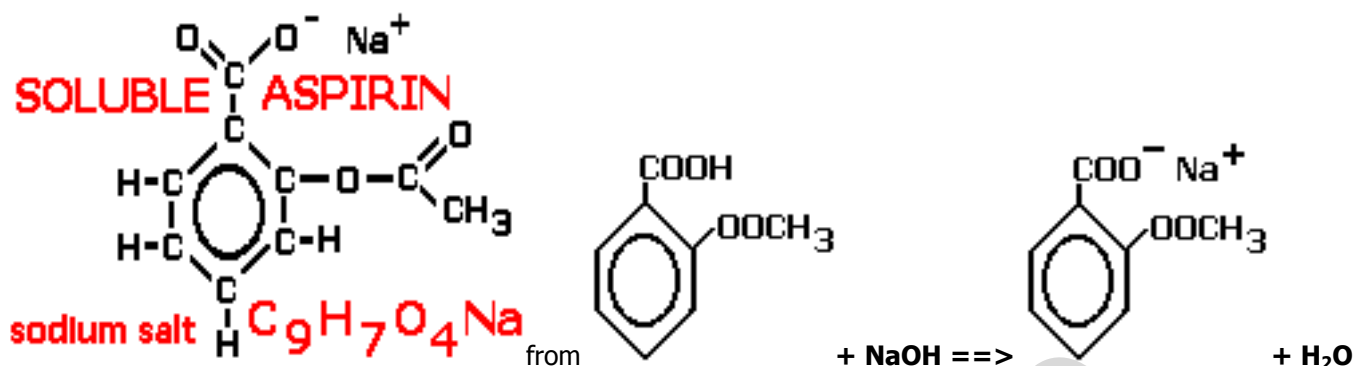

- The **modern pharmaceutical industry has its origins in herbal and other traditional medicine.**
- **eg** An extract of **willow herb** extract can be made from the leaves, bark and seeds of the willow tree. Amongst other ailments it was given to help curing feverish headaches and relief of pain in childbirth. When ingested the body hydrolyses and oxidises the naturally occurring 'precursor' molecule to form **salicylic acid*** which is the 'active' molecule in the body. in the 1890's the German chemist Hoffmann experimented with various chemical modifications of salicylic acid and found the best and chemically stable form was 'aspirin' (shown below). He **tried the variations on his own father!** who survived to provide valuable 'clinical trials' - hardly acceptable these days! * **'Oil of winter green'** from certain plants is the methyl ester of salicylic acid and has similar 'medicinal effects'.
- Aspirin (and the others shown) are not very soluble in water. **Soluble aspirin** is made by neutralising the carboxylic acid with the alkali sodium hydroxide to make the **much more soluble sodium salt of the acid**. The reaction, using skeletal formula, is shown in the diagram below the three analgesic drug structures.
- **New drugs and testing them:**
- It costs a lot of money to develop a new medicine so the price charged by the pharmaceutical company must cover the cost of research, production and marketing.
 - Patents are taken out to protect the company's commercial interests in the new medicine.
 - There can be a range of formulations of a particular medicine when you buy it over the counter eg tablet of 100% aspirin, soluble aspirin (via Na⁺ salt of the acid from neutralisation) and aspirin might form part of a mixture including substances that have other beneficial effects.
 - The main point here is that aspirin, like many drugs, can have multi-functional effects, hopefully all beneficial.
 - **BUT this, sadly, is not always the case, because with any new drug there is always the danger of unknown side-effects.**
 - Therefore there is a tremendous responsibility on pharmaceutical companies to ensure the development of safe and effective drugs.
 - **Lots of time and money spent on discovering and developing new drugs and there are lots of factors to consider:**
 - From the discovery of a potentially useful molecule, sometimes called the 'lead molecule', which can be from natural source or produced in some other project etc.
 - Is there room in the commercial market place for it?
 - **Do research to see if its safe**, otherwise further development is a waste of time and money **or if not safe, can its molecular structure be modified?**
 - **Can the modification be safe? and more effective?**
 - In what form, can it be/needs to be, administered in? for clinical trials.
 - **Carefully clinical trials in various phases, noting particularly if any side-effects which may be harmful.**

- **Do you test new drugs on animals? - an emotive issue, can non-animal testing always allow the safe development of new products?**
- **Do you test new drugs on patients in a life threatening situation, give them a last chance at some risk?**
- **Patient health and safety issues versus very big drug company commercial interests are a matter of public concern.**
- Any new drug must finally pass all the tests before legally licensed for patient consumption ...
 - **sadly, the 'drug companies' and the 'powers to be' do not always get it right (eg phthalidomide), but do not the benefits outweigh the occasional tragedy which we should do our best to avoid?**
- **Food additives are chemicals added to food to give particular effects eg colourings, flavourings, preservation and sweetening.**
 - **Colourings** to make food more attractive, to fit in with the consumers perception of what it should look like.
 - **Flavourings** to make food more 'tasty', less 'bland', and to fit in with the consumers perception of what it should taste like.
 - **Preservatives** are to increase the 'shelf-life' of packaged food, decrease risk of food poisoning.
 - **Sweeteners** counter bitterness or pander to our taste!
- **E-numbers are reference numbers used by the European Union to help identification of food additives.**
 - All food additives used in the European Union are identified by an E-number.
 - The "E" stands for "Europe" or "European Union".
 - Normally each food additive is assigned a unique number, though occasionally, related additives are given an extension (eg a,b,i or ii etc.) to another E-number.
 - The Commission of the European Union **assigns E-numbers after the additive is cleared by the Scientific Committee on Food (SCF)**, the body responsible for the **safety evaluation of food additives** in the European Union. A summary is given below.

E100-199 food colours

E200-299 preservatives

E300-399 anti-oxidants, phosphates, and complexing agents

E400-499 thickeners, gelling agents, phosphates, emulsifiers

E500-599 salts and related compounds

E600-699 flavourings

E700-899 not used for food additives (used for animal feed additives!)

E900-999 surface coating agents, gases, sweeteners

E1000-1399 miscellaneous additives

E1400-1499 starch derivatives

- E-numbers are only used for substances added directly to food products, so contaminants, enzymes and processing aids, which may be classified as additives in the USA, are not included in the E-number system.
- There is an EU directive on food labeling which requires food additives to be listed in the product ingredients whenever they are added for technological purposes.
 - This includes colouring, sweetening and flavor enhancement as well as for preservation, thickening, emulsifying and the like.
 - Ingredients must be listed in descending order of weight, which means that are generally found close to the end of the list of ingredients.
 - However, substances used in the protection of plants and plant products, flavorings and substances added as nutrients (e.g., minerals, trace elements or vitamins) do not need to be included in the ingredient list.
 - Because of this, some substances that are regulated as food additives in other countries may be exempt from

the food additive definition in the EU.

7. CFC's and Free Radicals (NOT FINISHED)

- **If enough energy** is supplied by heat or by visible/uv electromagnetic radiation, or the is weak enough, a **covalent bond can break in two ways**. This illustrated with the molecule **chloromethane CH₃Cl**.

- **Unevenly** where the electron bond pair can stick with one fragment and a positive and negative ion form.
 - eg $\text{CH}_3\text{Cl} \implies \text{CH}_3^+ + \text{Cl}^-$ (at AS-A2 level this is called **heterolytic bond fission**)

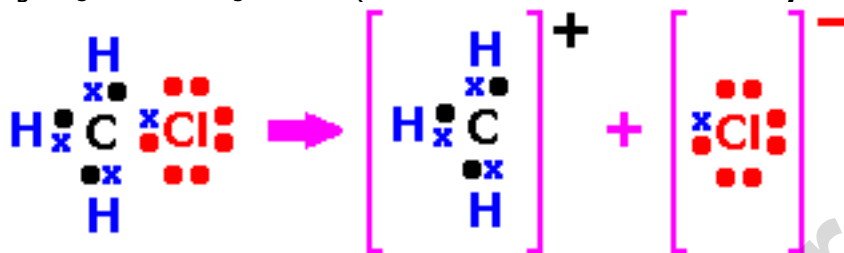

shows what happens to the molecule

- or **evenly**, where the bonding pair of electrons are equally divided between two highly reactive fragments called **free radicals**.

- Free radicals are characterised by having **an unpaired electron** not involved in a chemical bond.
- The \cdot means the 'lone' electron on the free radical, which is not part of a bond anymore, and wants to pair up with another electron to form a stable bond - that's why free radicals are so reactive!
- eg $\text{CH}_3\text{Cl} \implies \text{CH}_3\cdot + \cdot\text{Cl}$ (at AS-A2 level this is called **homolytic bond fission**)

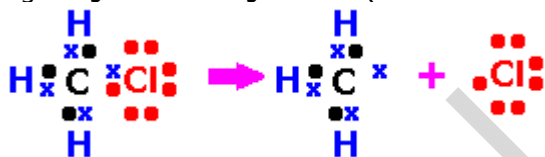

shows what happens to the molecule

- In the stratosphere small amounts of unstable **ozone O₃ (trioxygen)** are formed by free radical reactions.
- The **chemistry of free radicals** is important in the current environmental issue of **ozone layer depletion**.
 - **Chlorofluorocarbons (CFC's for shorthand)** are organic molecules containing carbon, fluorine and chlorine
 - eg dichlorodifluoromethane has the formula CCl₂F₂
 - They are very useful low boiling organic liquids or gases, until recently, extensively used in **refrigerators** and **aerosol sprays** eg repellents.
 - They are **relatively unreactive, non-toxic and have low flammability**, so in many ways they are 'ideal' for the job they do.
- However it is their chemical stability in the environment that eventually causes the ozone problem but first we need to look at **how ozone is formed and destroyed** in a '**natural cycle**'. This presumably has been in balance for millions of years and explains the uv ozone protection in the upper atmosphere.
- **Ozone is formed in the stratosphere by free radical reactions**.
 - 'ordinary' stable **oxygen O₂ (dioxygen)** is split (dissociates) into two by high energy **ultraviolet radiation (uv photon energy 'wave packets')** into two oxygen atoms (which are themselves radicals) and then a 'free' oxygen atom combines with an oxygen molecule to form ozone.
 - $\text{O}_2 + \text{uv} \implies 2\text{O}\cdot$ then $\text{O}\cdot + \text{O}_2 \implies \text{O}_3$
 - The ozone is a highly reactive and unstable molecule and decomposes into dioxygen when hit by other uv light photons. The oxygen atom radical can do several things including help forming O₃, and O₂.
 - $\text{O}_3 + \text{uv} \implies \text{O}_2 + \text{O}\cdot$
 - This last reaction is the main **uv screening effect** of the upper atmosphere and the ozone absorbs a lot of the harmful incoming uv radiation from the Sun.
 - **If the ozone levels are reduced more harmful uv radiation reaches the Earth's surface and can lead to medical problems such as increased risk of sunburn and skin cancer and it also accelerates skin aging processes.**
 - **There is strong evidence to show there are 'holes' in the ozone layer with potentially harmful**

effects, so back to the CFC problem!

- The **chemically very stable CFCs diffuse up into the stratosphere** and decompose when hit by ultraviolet light (uv) to produce free radicals, including free chlorine atoms, which themselves are highly reactive free radicals.
 - eg $\text{CCl}_2\text{CF}_2 \Rightarrow \text{CClF}_2\cdot + \text{Cl}\cdot$ (note the C-Cl bond is weaker than the C-F bond)
- The **formation of chlorine atom radicals is the root of the problem** because they readily react with ozone and change it back to much more stable ordinary oxygen.
 - $\text{O}_3 + \text{Cl}\cdot \Rightarrow \text{O}_2 + \text{ClO}\cdot$ bye bye ozone! and no uv removed in the process!
- Therefore **many countries are banning the use of CFCs**, but not all despite the fact that scientists predict it will take many years for the depleted ozone layer to return to its 'original' O_3 concentration.

Mega Lecture