

Ray-Notes® 2009

O-Level Sc (Physics) v2.0

General notes and definitions for instant revision

Hong Ray Corporations®

www.megalecture.com



09

Physics Definitions

1. **Speed** – Distance travelled per unit time.
2. **Velocity** – Rate of change of displacement.
3. **Acceleration** – Rate of change of velocity.
4. **Electromagnetic induction** is the phenomenon of producing an emf in a circuit due to changing magnetic field.
5. **Amplitude** refers to the maximum displacement from rest position.
6. Wavelength refers to the distance between one crest to the next successive crest.
7. **Frequency** refers to the number of waves produced per unit time.
8. **Period** refers to the time taken for one complete wave.
9. **Speed** refers to the distance travelled by the wave per unit time.
10. **Echo** is reflected sound from hard and smooth surfaces.
11. **Sound** is produced by vibrations placed in a medium
12. A **Wave** is a phenomenon in which energy is transferred through vibrations
13. **Transverse waves** are waves where the direction of travel is perpendicular to the direction of vibration of particle in a medium. (Light/water are transverse waves)
14. **Longitudinal waves** are waves where the direction of travel is parallel to the direction of vibration of particles in a medium. (Sound is longitudinal wave)
15. **Kinetic energy** – The ability to do work due to the object's speed.
16. **Gravitational Potential energy** – The ability to do work due to the object's height.
17. **Inertia** is an object's resistance to a change in velocity. (Heavier objects have greater inertia)
18. **Work** is done when an object moves in the same direction of the force acting on it.
19. **Refraction** is the bending of light ray as it travels across 2 different mediums.
20. **Density – Mass per unit volume**

General Physics notes

(Exam Notes for this subject is posted in random order)

- Read thru this set of notes before entering the exam hall!
- If you see this symbol: ♂ the topic might be only for students taking Pure Physics.
- This is the first release of Physics Notes from Ray-Notes®, please feedback or provide suggestions for improvements.

♂ Ways to increase emf in solenoid

1. Use a stronger magnet.
2. Increase the speed of moving the magnets.
3. Increase the number of turns on the coil.

♂ Ways to increase emf in a.c. generator

1. Decrease distance between the magnet and coil.
2. Use a stronger magnet.
3. Increase speed of moving the magnets
4. Increase number of turns in the coil.

(emf refers to electromotive force, which can also be considered as 'voltage')

When a water wave moves from deep to shallow,

- Wavelength become shorter
- Frequency remains the same
- Speed becomes slower

Extra info:

Temperature can be measured using the following methods:

- Expansion of fixed mass of liquid.
- Changes of resistance of a piece of metal with time.
- Expansion of gas at constant pressure.

Factors that affect speed of sound

1. **Temperature** – The higher, the faster
2. **Medium** – Solid is faster than liquid, which is faster than gas
3. **Humidity** – More humid faster than less humid

Characteristics of *Image formed on plane mirror*

- 1) Same size
- 2) Laterally inverted
- 3) Image is virtual

What is 'Moment of a force about a point'?

- The turning effect it causes on the body about the pivot.

Principle of moments

- The sum of clockwise moments about a point is equal to the sum of anti-clockwise moments about the same point,
- $\text{Moment} = \text{Force} \times \text{Perpendicular distance from pivot.}$

Center of Gravity/Mass

- The point which the weight of the object appears to act.

Why constant temperature at melting?

- During melting, heat energy is used to weaken the attraction between the solid particles so that they can roll and slide over one another and become liquid particles.
- The heat energy is not used to increase the Kinetic energy of particles.

Note:

Convection occurs when there is difference in density

Radiation occurs when there is difference in surrounding temperatures.

When a thermometer is placed into hot water, why the reading drops first then increases.

- The glass bulb expands before the mercury expands.

Energy changes of a oscillating pendulum as it comes to rest.

- Due to friction and air resistance, kinetic energy will be changed to heat energy.

♂Precautions when handling radioactive substances

- 1) Radioactive substances should not be touched.
- 2) Do not point their rays at any person.
- 3) Wear a photosensitive badge to check whether a person is exposed to an overdose of radiation.

♂ Operation of Transformer

1. Alternating current is supplied to primary coil.
2. Alternating current causes iron core to magnetise and magnetic field to change.
3. Magnetic fields follow iron core and link to secondary coil.
4. Hence emf is induced in secondary coil by electromagnetic induction.

♂ Operation of AC Generator

1. Turn the wire.
2. The wire cuts through the magnetic field as it turns.
3. This produces an induced emf.
4. Because of the load, an induced current is produced.

Electromagnetic Spectrum

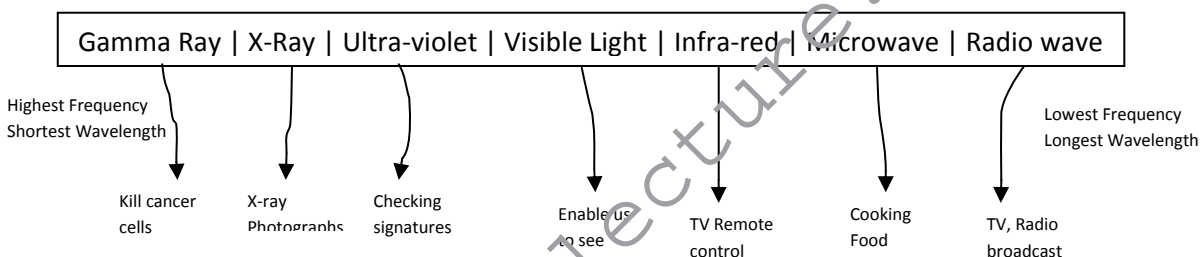

Note:

An image that is real is always inverted!

An image that is Virtual is always upright!

(REAL – INVERTED)

(VIRTUAL – UPRIGHT)

Note: If an object is moving at constant speed, the resultant force is zero!

If a car is driving around a circle at a constant speed, its velocity is not constant!

*The Car is accelerating!

(Because Velocity has magnitude and direction. When the car is turning around the circle, its direction changes constantly)

Remember: Speed has magnitude only, Velocity has magnitude and direction.

*Acceleration is the rate of change of velocity. → A change in velocity is acceleration.

How to check if *point C* is the center of gravity of the object?

- If the metal sheet can be balanced on the tip of the finger directly below point C, then it is the center of gravity.

How to measure period of a pendulum?

- Measure the time 't' for 20 oscillations with a stop-watch
- Calculate the average time for 1 complete oscillation, $T = t/20$

Extra info: When the current in the electric circuit increases, its temperature increases, and then it will cause its resistance to increase.

Current Increase → Temperature increase → Resistance increase

Examples of Energy Changes

- **Kinetic to Gravitational Potential Energy (GPE)**
- A man running up a flight of stairs.
- **Chemical to Heat**
- A lighted Candle
- **Gravitational Potential Energy (GPE) to Kinetic Energy**
- A car speeding down a hill.

Note: Heat/energy from the sun reaches Earth by Radiation!!

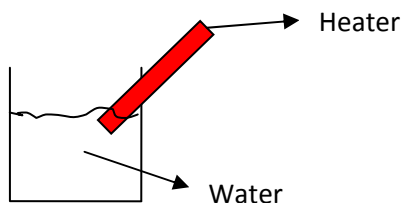
**Why no convection current if heated from top?**

- The hot less dense water remains at the top while the cold denser water remains at the bottom. Hence no convection current is produced.

How heat is lost when a hot bowl is moved from oven to table?

- Heat is lost by radiation because the hot bowl is at a higher temperature than its surroundings.
- Heat is also lost by convection. The hot air above the hot bowl is less dense than the surrounding air.

General note: Convection is due to difference in Density. Radiation is due to diff in temp.

Constriction in Clinical Thermometer:

Used to prevent mercury from falling back into the bulb when it is removed from the patient's mouth or armpit.

Electric Circuits

Note: Just remember that for whatever circuits, the voltage is always constant!

So if the current increase, the resistance must decrease..

If the resistance increase, the current must decrease..

- In other words, the higher the current in the circuit, the lower is the resistance of the circuit.

$$\text{Voltage} = \text{Resistance} \times \text{Current}$$

↓
Constant

Calculating resistance:

For parallel circuits

$$\frac{1}{R_1} + \frac{1}{R_2} + \frac{1}{R_3} = \text{Total resistance}$$

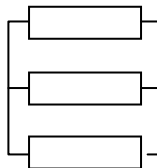

For Series circuit

$$R_1 + R_2 + R_3 = \text{Total resistance}$$

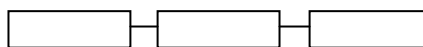

When a light bulb is switched on, why the filament reaches a constant temperature?

- The power dissipated in the filament becomes equal to the rate of heat radiated by it.

Note: Colour is linked to radiation.

- Black is good absorber & emitter of heat.

Why better to push at B than A?

- The turning effect produced when force is applied at B is greater.
(Turning effect = Force x Distance)

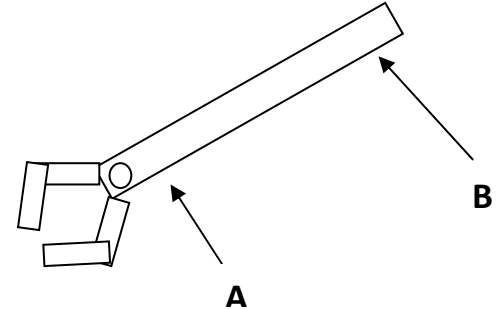

Effect of applying force on a rusty bolt/nut.

- It will change the shape of edges of nut.
- Heat will be produced because of friction, It might also break.

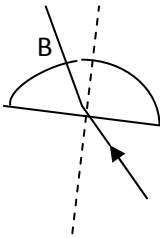

Why ray not change direction at B?

- The ray is perpendicular to the boundary.

Image produced by a magnifying glass:

- Virtual, Upright, Magnified.

Emf of a cell

- “ Total energy used to drive unit charge round the complete circuit.”

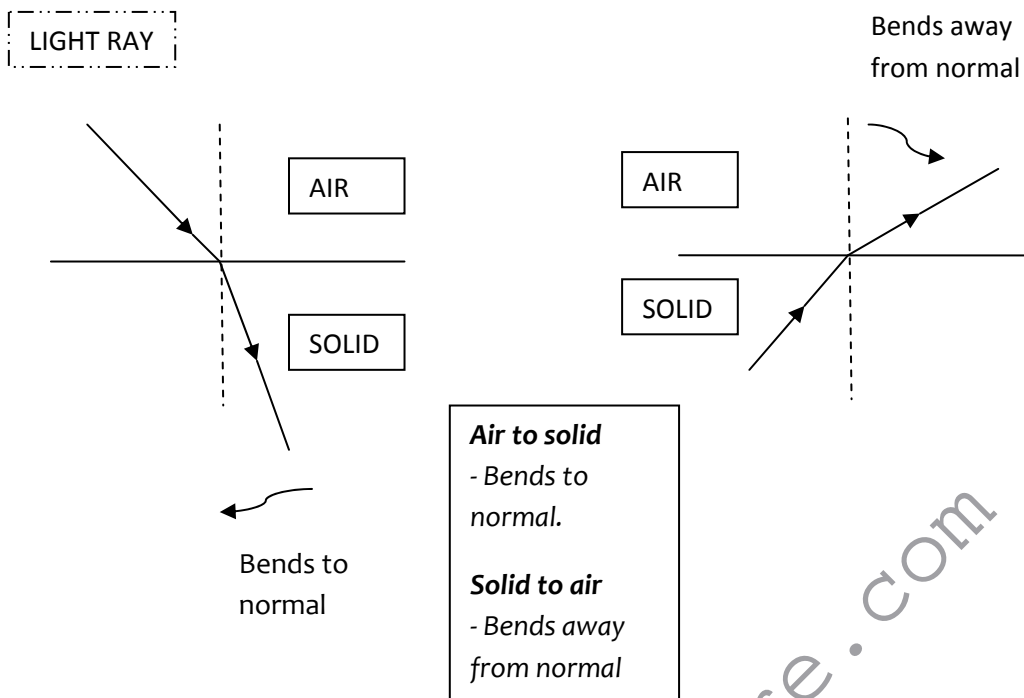

Note: When doing calculations for Physics, All units must be changed to its SI units. E.g. Mass must be calculated in KG, Distance must be calculated in Metres. If not, answers will be wrong.

Comparing speeds of Light

- In a vacuum, speed of red light and speed of blue light is the same. (All electromagnetic waves travel at same speed in a vacuum.)
- In a glass, speed of blue light is slower than speed of red light because Blue light has shorter wavelength but same frequency.

How sound waves travel through air?

- By producing alternate compressions and rarefactions along the path of air particles.

Good radiator of heat

- Black surface
- Rough surface

Ice point – The melting point of pure ice under normal pressure acting on it.

Process of creating Convection current

1. The bottom layer is heated, the molecules move faster.
2. The density decreases and hot water rises.
3. Cooler and denser water above sinks down and takes its place.
4. Convection current is due to a change in density.

Difference between evaporation & boiling:

EVAPORATION

- 1) Takes place on the surface
- 2) Temperature may change in this process
- 3) Takes place at any temperature

BOILING

- Occurs throughout the liquid
- Temperature remains constant
- Takes place at a constant temp.

Characteristics of Image formed on plane mirror.

1. It is same size as the object
2. It is virtual
3. Laterally inverted

In a sound wave,

- The frequency affects the pitch
- Amplitude affects the loudness
- Quality affects the tone *of the sound*.

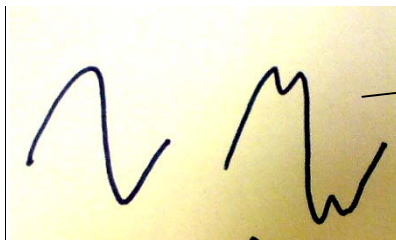

Both waves have different quality
(Different sound tones)

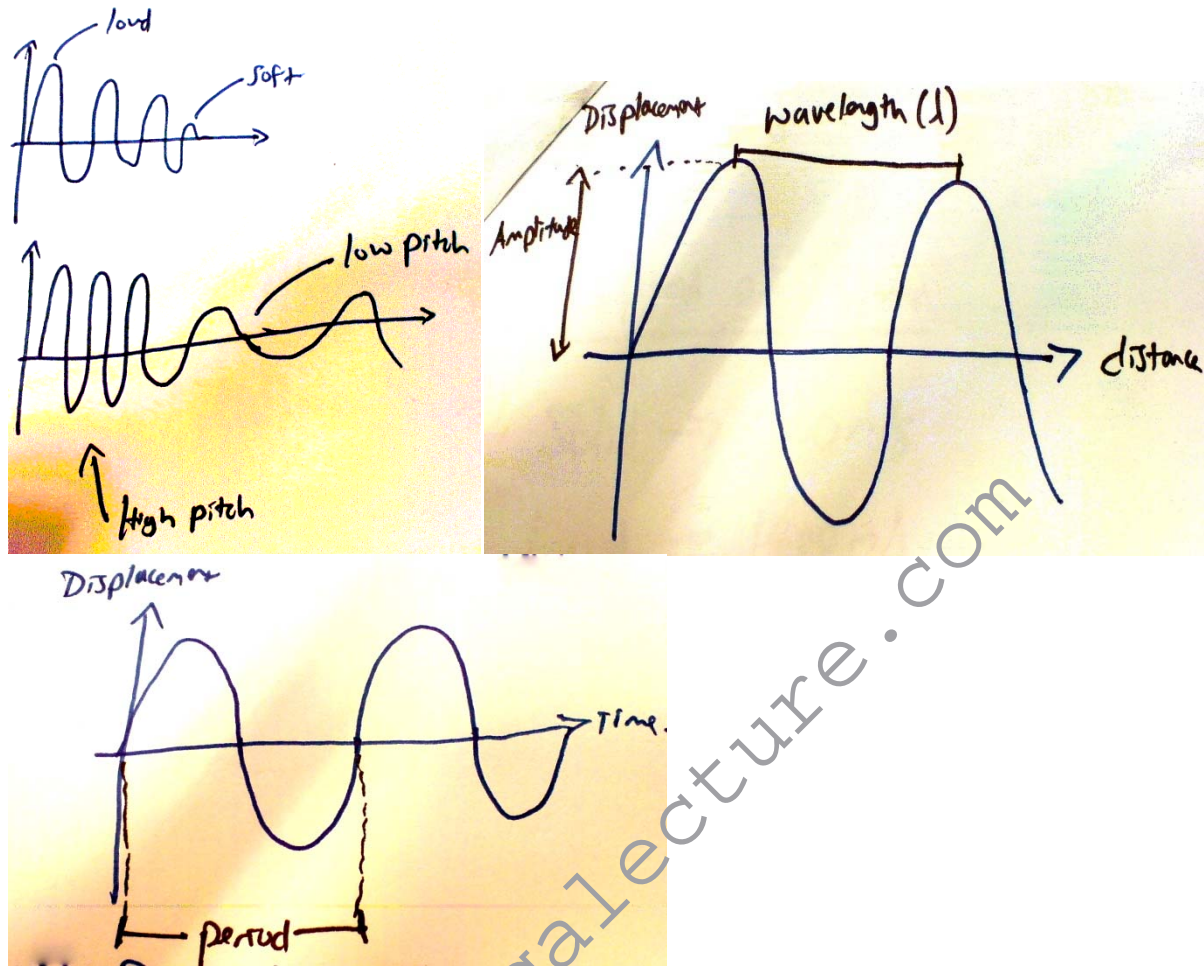

Human Hearing range

20Hz → 20KHz (20 000 Hz)

Lower frequency (Below 20Hz) – Infrasound

Higher Frequency (Above 20 000Hz) – Ultrasound

Compression and Rarefactions of sound wave

- **Compression** occur when the air particles are *closer together* and the air pressure is *higher* than the surrounding pressure.
- **Rarefaction** occurs when the air particles are *further apart* and the air pressure is *lower* than the surrounding pressure.

Compression & Rarefaction
only occur in Longitudinal
Waves

(Not transverse waves)

===== End of Science (Physics) O-Level (General Edition) v2.0 =====

Clear your Doubts with teachers now! Never wait, or you'll regret...

For more Physics notes, download them from <http://www.ray-revision.webs.com>

Recommended: Download the “Full Physics Formula” sheet and memorise them before going for the paper.

Need more notes? Suggest what you need. Ray-Notes® will do our best to provide the best possible resources for you, at no cost.